



# B38 Series Commercial & Industrial Regulator



Advanced Metering  
and Regulation  
Technology at Work



## Features

- Interchangeable orifice
- 78 in<sup>2</sup> of diaphragm area
- Spring-loaded internal relief valve assembly
- Field interchangeable adjustment spring
- Controlled breather orifice size eliminates pulsation and provides normal actuation at low flows
- Wide range of valve body sizes including NPT and Flange connections

## Benefits

- 2-1/2" relief vent provides exceptional internal relief performance; replaces the need for external relief valves
- Valve body takes up to 1 3/8" orifice for increased capacity
- Fast response protects equipment from shock damage
- Large 12" diaphragm for smooth outlet pressure control
- Unmatched overpressure protection with Internal Monitor plus Internal Relief (IMR) option
- No special tools required for outlet pressure adjustment
- Single Valve body with built-in monitor operation (IM models only)
- Internal Monitor is designed to meet D.O.T. Safety Standards

## Application

Appropriate for large capacity commercial and industrial uses where inches of water column or pounds delivery is desired such as utility services, gas engines, burner trains, furnaces, and boilers. The rapid response of the B38 is particularly well suited for applications where sudden on/off loads could cause shock problems.

## Model Descriptions

**B38N** – The B38N is a spring loaded self-operated regulator with no internal relief (N) valve. This model can be used on low or intermediate inlet pressures where an internal relief, or other type of over-pressure protection device is not required.

**B38R** - The B38R is the internal relief (R) version of the B38 Series. The large 2-1/2" internal relief valve provides exceptional relief capacity.

**B38M** – Used in a series monitoring installation as the upstream regulator. The B38M has an O-ring seal on the valve stem through the throat and a 1/2" control line tap on the lower diaphragm case.

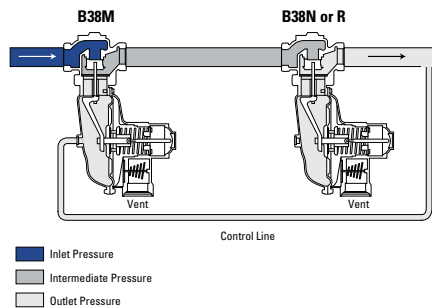

**B38IMN** – The B38IMN is equipped with an Internal Monitoring (IM) device and no internal relief valve (N). This version is appropriate for

applications where overpressure protection is desired without the relief of gas to the atmosphere.

**B38IMR** – The B38IMR is equipped with an Internal Monitoring (IM) device as well as a back-up Internal Relief Valve (R). This version is appropriate for applications where an added level of overpressure protection is desired.

**B38IMRV** - The B38IMRV is equipped with an Internal Monitoring (IM) device as well as a back-up Internal Relief Valve (R) and a Vent (V) hole in the sliding orifice. The Vent hole option allows the relief valve to "weep" gas to the atmosphere and signal a problem with the regulator in the event the Internal Monitor comes into operation.

## Option Designations

- N** – No Internal Relief
- R** – Internal Relief
- MN** – Closed throat with control line tap and no internal relief
- MR** – Closed throat with control line tap and internal relief valve
- IMN** – Internal Monitor with no Internal Relief
- IMR** – Internal Monitor with Internal Relief
- IMRV** – Internal Monitor with Internal Relief and Vent

## Operating Principle

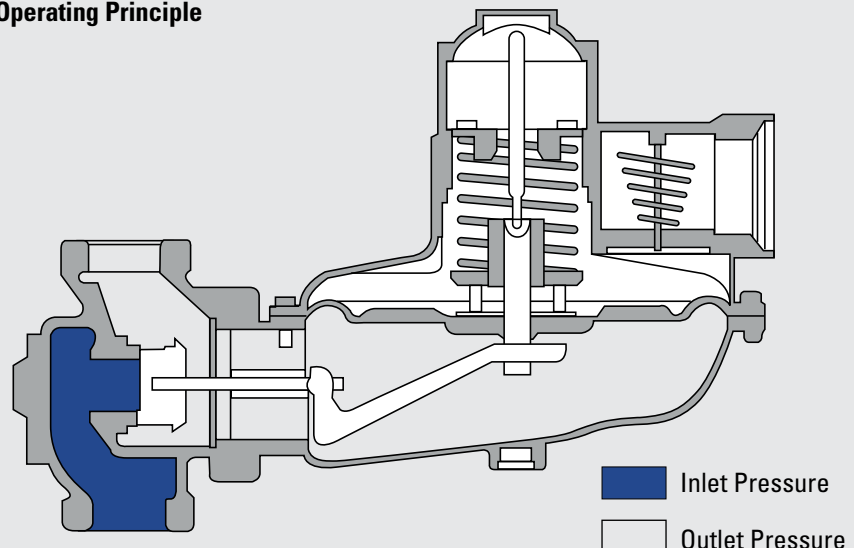

# Specifications

## Material Construction:

Valve Body:	High tensile strength cast iron (ASTM A-126, Class A)
Orifice (Standard and IM):	Brass (ASTM B16, Alloy 360)
Valve Seat:	Buna-N
Valve Stem:	Plated steel (AISI 1215)
Lever Pin:	Stainless steel (Type 303)
Lever:	Zinc and dichromate plated steel (AISI C1010)
Upper Diaphragm Plate:	Zinc and dichromate plated steel (14 gauge steel)
Lower Diaphragm Plate:	Die cast aluminum (ASTM B-85 Alloy SC84A)
Diaphragm:	Buna-N and nylon reinforcing fabric
Vent Valve/Seat:	Neoprene
Vent Screen:	Stainless Steel (16 mesh)
Adjustment Ferrule:	Die cast aluminum (ASTM CS43A)
Seal Cap:	Die cast aluminum (ASTM CS43A)
Diaphragm Case:	Die cast aluminum (ASTM B85 – Alloy SC84A)

## Shipping Weight:

(one per box):	2" NPT – 25 lbs.
	2" Flanged – 35 lbs.
	3" Flanged – 45 lbs.

## Correction factors for non-natural gas applications:

The B38 may be used to control gases other than natural gas. To determine the capacity of the B38 for gases other than natural gas, it will be necessary to multiply the values within the capacity tables by a correction factor. The table below lists the correction factors for some of the more common gases:

Gas Type	Specific Gravity	Correction Factor (CF)
Air	1.0	0.77
Butane	2.01	0.55
Carbon Dioxide (Dry)	1.52	0.63
Carbon Monoxide (Dry)	0.97	0.79
Natural Gas	0.60	1.00
Nitrogen	0.97	0.79
Propane	1.53	0.63
Propane-Air-Mix	1.20	0.71

To calculate the correction factor for gases not listed on the table above, it will be necessary to know the specific gravity of the gas and use it in the formula listed below:

$$\text{Correction Factor (CF)} = \sqrt{\frac{SG_1}{SG_2}}$$

Where:

SG<sub>1</sub> = Specific Gravity of the gas in which the capacity is published.

SG<sub>2</sub> = Specific Gravity of the gas to be controlled.

## Spring Range Data MODELS N, R, M, D (See Spring Data for IM Models on Page 16)

B38 - ADJUSTED OUTLET PRESSURE RANGE  
SPRING ADJUSTMENT FERRULE AT MIN. AND MAX. DEPTHS

Orifice Size	Inlet Pressure	Spring Color	Outlet Pressure Min.	Outlet Pressure Max.	Orifice Size	Inlet Pressure	Spring Color	Outlet Pressure Min.	Outlet Pressure Max.				
3/8"	25 PSIG	ORANGE	3.3" WC	4.5" WC	3/4"	25 PSIG	ORANGE	4.2" WC	6.2" WC				
		BROWN	4.45" WC	6.2" WC			BROWN	4.3" WC	7.1" WC				
		GREEN	5.5" WC	7.75" WC			GREEN	6.3" WC	9.0" WC				
		BLACK	8.1" WC	13.6" WC			BLACK	9.4" WC	15.0" WC				
		PURPLE	12.4" WC	21.2" WC			PURPLE	13.7" WC	22.25" WC				
		BLUE	14.1" WC	27" WC			BLUE	17.1" WC	1.11 PSIG				
		BLUE/WHITE	0.93 PSIG	1.60 PSIG			BLUE/WHITE	0.96 PSIG	1.63 PSIG				
		SILVER	1.31 PSIG	2.47 PSIG			SILVER	1.42 PSIG	2.51 PSIG				
		SILVER/RED	1.71 PSIG	2.92 PSIG			SILVER/RED	1.80 PSIG	2.95 PSIG				
		YELLOW	2.25 PSIG	4.15 PSIG			YELLOW	2.54 PSIG	4.18 PSIG				
		RED NESTED	1.75 PSIG	6.75 PSIG			RED NESTED	1.88 PSIG	6.79 PSIG				
		WHITE NESTED	2.0 PSIG	7.7 PSIG			WHITE NESTED	2.0 PSIG	7.8 PSIG				
		1/2"	25 PSIG	ORANGE			2.25" WC	4.5" WC	1"	25 PSIG	ORANGE	5.0" WC	5.9" WC
				BROWN			3.5" WC	5.9" WC			BROWN	5.4" WC	7.8" WC
GREEN	5.0" WC			8.2" WC	GREEN	7.5" WC	10.0" WC						
BLACK	8.5" WC			13.95" WC	BLACK	10.9" WC	16.1" WC						
PURPLE	12.7" WC			21.4" WC	PURPLE	15.0" WC	23.75" WC						
BLUE	16.2" WC			1.02 PSIG	BLUE	18.25" WC	1.17 PSIG						
BLUE/WHITE	0.96 PSIG			1.63 PSIG	BLUE/WHITE	1.04 PSIG	1.73 PSIG						
SILVER	1.38 PSIG			2.50 PSIG	SILVER	1.51 PSIG	2.69 PSIG						
SILVER/RED	1.71 PSIG			2.99 PSIG	SILVER/RED	1.88 PSIG	3.06 PSIG						
YELLOW	2.48 PSIG			4.15 PSIG	YELLOW	2.53 PSIG	4.22 PSIG						
RED NESTED	1.76 PSIG			6.66 PSIG	RED NESTED	2.11 PSIG	6.94 PSIG						
WHITE NESTED	2.0 PSIG			7.7 PSIG	WHITE NESTED	2.1 PSIG	7.8 PSIG						
5/8"	25 PSIG			ORANGE	3.8" WC	4.5" WC	1 1/4"	10 PSIG			ORANGE	3.5" WC	4.3" WC
				BROWN	5.4" WC	7.3" WC					BROWN	5.2" WC	7.3" WC
		GREEN	6.4" WC	9.2" WC	GREEN	5.8" WC			9.7" WC				
		BLACK	9.25" WC	14.8" WC	BLACK	9.4" WC			14.9" WC				
		PURPLE	12.7" WC	21.4" WC	PURPLE	13.5" WC			22.2" WC				
		BLUE	15.9" WC	29.45" WC	BLUE	17.3" WC			29.8" WC				
		BLUE/WHITE	0.91 PSIG	1.61 PSIG	BLUE/WHITE	26.85" WC			1.64 PSIG				
		SILVER	1.14 PSIG	2.56 PSIG	SILVER	1.44 PSIG			2.59 PSIG				
		SILVER/RED	1.67 PSIG	2.90 PSIG	SILVER/RED	1.83 PSIG			2.95 PSIG				
		YELLOW	2.47 PSIG	4.10 PSIG	YELLOW	2.50 PSIG			4.14 PSIG				
		RED NESTED	1.77 PSIG	6.62 PSIG	RED NESTED	1.90 PSIG			6.63 PSIG				
		WHITE NESTED	2.0 PSIG	7.7 PSIG	WHITE NESTED	2.1 PSIG			7.8 PSIG				
				ORANGE					1 3/8"	10 PSIG	ORANGE	3.0" WC	4.6" WC
				BROWN							BROWN	3.95" WC	6.4" WC
GREEN					GREEN	5.0" WC	8.0" WC						
BLACK					BLACK	9.6" WC	15.3" WC						
PURPLE					PURPLE	13.5" WC	22.2" WC						
BLUE					BLUE	17.75" WC	30.2" WC						
BLUE/WHITE					BLUE/WHITE	27.4" WC	1.66 PSIG						
SILVER					SILVER	1.42 PSIG	2.54 PSIG						
SILVER/RED					SILVER/RED	1.85 PSIG	2.99 PSIG						
YELLOW					YELLOW	2.52 PSIG	4.16 PSIG						
RED NESTED					RED NESTED	1.96 PSIG	6.71 PSIG						
WHITE NESTED					WHITE NESTED	2.1 PSIG	7.8 PSIG						

## OUTLET PRESSURE CHANGE AS A RESULT OF A 10 PSIG INLET PRESSURE CHANGE ORIFICE SIZE - INCHES

SPRING COLOR	3/8"	1/2"	5/8"	3/4"	1"	1-1/4"	1 3/8"
ORANGE	0.2" WC	0.3" WC	0.65" WC	0.9" WC	1.1" WC	1.8" WC	1.1" WC
BROWN	0.25" WC	0.3" WC	0.4" WC	0.9" WC	1.1" WC	1.4" WC	1.2" WC
GREEN	0.3" WC	0.4" WC	0.6" WC	0.7" WC	1.2" WC	2.0" WC	1.4" WC
BLACK	0.3" WC	0.4" WC	0.6" WC	0.7" WC	1.6" WC	2.1" WC	2.3" WC
PURPLE	0.3" WC	0.4" WC	0.55" WC	0.8" WC	1.7" WC	1.8" WC	2.0" WC
BLUE	0.4" WC	0.02 PSIG	0.55" WC	1.0" WC	1.7" WC	2.0" WC	2.8" WC
BLUE/WT	0.01 PSIG	0.04 PSIG	0.02 PSIG	0.03 PSIG	0.06 PSIG	0.08 PSIG	0.11 PSIG
SILVER	0.01 PSIG	0.04 PSIG	0.06 PSIG	0.03 PSIG	0.07 PSIG	0.12 PSIG	0.13 PSIG
SIL/RED	0.02 PSIG	0.03 PSIG	0.04 PSIG	0.03 PSIG	0.08 PSIG	0.10 PSIG	0.11 PSIG
YELLOW	0.03 PSIG	0.04 PSIG	0.03 PSIG	0.05 PSIG	0.09 PSIG	0.12 PSIG	0.15 PSIG
RED NESTED	0.03 PSIG	0.05 PSIG	0.05 PSIG	0.10 PSIG	0.13 PSIG	0.19 PSIG	0.23 PSIG
WHITE NESTED	.03 PSIG	.05 PSIG	0.05 PSIG	0.13 PSIG	0.16 PSIG	0.24 PSIG	0.28 PSIG

\* Spring Ranges are approximate and may vary by application

# Specifications (continued)

## ORIFICE DATA: Wide Open Orifice Coefficients and Maximum Pressure Data

Orifice Size	K-Factor (scfh/psi)	Maximum Operating Inlet Pressure				Maximum Emergency Inlet Pressure	Maximum Emergency Outlet Pressure (Gas Containment)
		< 1 PSIG Outlet N & R Models PSIG (Bar)	< 1 PSIG Outlet D & M Models PSIG (Bar)	< 1 PSIG Outlet IMN & IMR Models PSIG (Bar)	> 1 PSIG Outlet All Models PSIG (Bar)	All Models All outlet pressures PSIG (Bar)	All Models All outlet pressures PSIG (Bar)
3/8"	305	125 (8.6)	175 (12.1)	---	175 (12.1)	300 (20.6)	30 (2.0)
3/8" IM	265	---	---	125 (8.6)	175 (12.1)	300 (20.6)	30 (2.0)
1/2"	500	125 (8.6)	125 (8.6)	---	175 (12.1)	300 (20.6)	30 (2.0)
1/2" IM	410	---	---	125 (8.6)	175 (12.1)	300 (20.6)	30 (2.0)
5/8"	700	75 (5.2)	125 (8.6)	---	150 (10.3)	300 (20.6)	30 (2.0)
5/8" IM	667	---	---	60 (4.1)	150 (10.3)	300 (20.6)	30 (2.0)
3/4"	1000	60 (4.1)	125 (8.6)	---	150 (10.3)	300 (20.6)	30 (2.0)
3/4" IM	750	---	---	60 (4.1)	150 (10.3)	300 (20.6)	30 (2.0)
1"	1500	60 (4.1)	100 (6.9)	---	100 (6.9)	170 (11.7)	30 (2.0)
1" IM	925	---	---	30 (2.1)	100 (6.9)	170 (11.7)	30 (2.0)
1-1/4"	1700	40 (2.8)	75 (5.2)	---	75 (5.2)	125 (8.6)	30 (2.0)
1-3/8"	2000	25 (1.7)	50 (3.4)	---	50 (3.4)	100 (6.9)	30 (2.0)

MAXIMUM EMERGENCY OUTLET PRESSURE (no damage): 8.7 psig (0.6 bar)

### VALVE BODY SIZES

Inlet	Outlet	Screwed (NPT)	Flanged (ANSI 125)
1-1/2"	1-1/2"	Y	---
2"	2"	Y	Y
3"	3"	---	Y

Y indicates that the valve body is available in that configuration

### WIDE-OPEN FLOW CALCULATIONS

For wide-open orifice flow calculations use the following equations:

$$\text{For } P_1/P_2 < 1.89 \text{ use: } Q = K \sqrt{P_2 (P_1 - P_2)}$$

$$\text{For } P_1/P_2 > 1.89 \text{ use: } Q = \frac{KP_1}{2}$$

Where:  $P_1$  = absolute inlet pressure (psia)  
 $Q$  = flow rate (scfh)

$P_2$  = absolute outlet pressure (psia)  
 $K$  = orifice coefficient (scfh/psi)

**Available Vent Sizes:** 1" NPT on non-internal relief (N) models only  
 2-1/2" NPT (Standard) on internal relief (R) models only  
 2" NPT (Optional) – Warning: The 2" relief size will reduce relief capacity

### Operating Temperature

**Range:** -20 F to 150 F

**Loading Ring Position:** For outlet pressure < 1 psig: 40 degrees  
 For outlet pressure ≥ 1 psig: 0 degrees

**Other Available Options:** - Seal wire to indicate unapproved tampering  
 - 1/8" pipe plug tap on upstream side of valve body

# B38 Dimensions

Valve Body Type	Models	A	B	C	D	E	F	G	H	R
1-1/2" OR 2" NPT	N, DN, MN, IMN	7 1/2"	3 3/4"	10 5/8"	12 7/8"	4 5/16"	9 5/8"	2 3/16"	6 3/4"	3 3/8"
	R, DR, MR, IMR, IMRV	7 1/2"	3 3/4"	10 5/8"	13"	5"	9 5/8"	2 3/16"	6 3/4"	3 3/8"
2" Flanged	N, DN, MN, IMN	10"	5"	10 5/8"	12 7/8"	4 5/16"	9 5/8"	2 3/16"	6 1/2"	3 15/16"
	R, DR, MR, IMR, IMRV	10"	5"	10 5/8"	13"	5"	9 5/8"	2 3/16"	6 1/2"	3 15/16"
3" Flanged	N, DN, MN, IMN	10"	5"	10 5/8"	12 7/8"	4 5/16"	9 5/8"	2 3/16"	7 3/8"	4 3/16"
	R, DR, MR, IMR, IMRV	10"	5"	10 5/8"	13"	5"	9 5/8"	2 3/16"	7 3/8"	4 3/16"

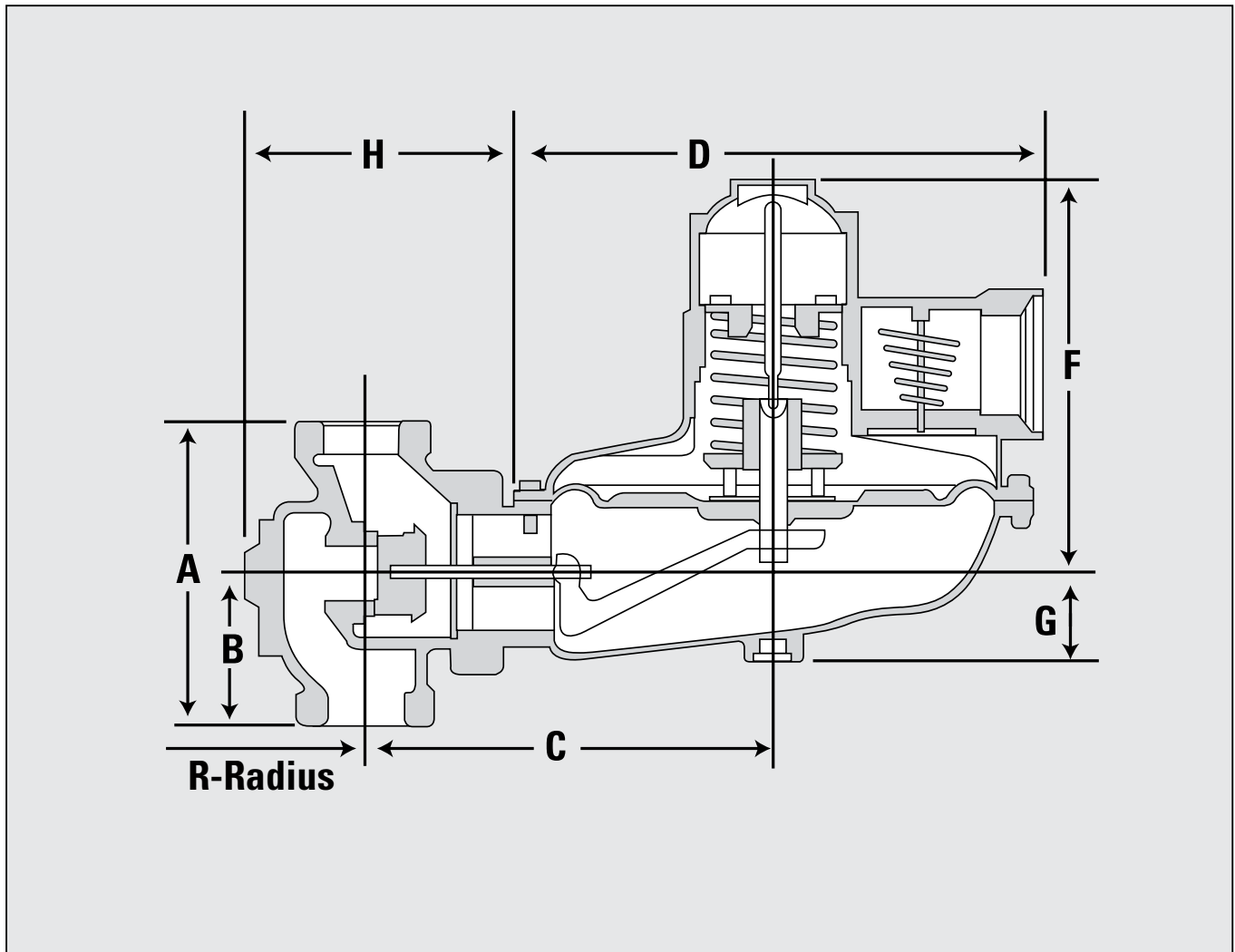

# B38 Commercial & Industrial Regulator - 7" (17 mbar) Capacity Table (1" Droop) – Models N, R, DN, DR, MN, MR

(IM Model Capacity tables located in back section of this document)

Set Point: 7" w.c. (17.5 mbar) @ 200 scfh (5.68 m<sup>3</sup>/h)



Green Spring - Part No. 762353

Valve Body: 2" x 2" NPT

Mounting Position 11

Inlet Pressure		Loading Ring Setting	Capacities in scfh (m <sup>3</sup> /hr) by Orifice Size							
			3/8" 9.52 mm	1/2" 12.7 mm	5/8" 15.9 mm	3/4" 19.1 mm	1" 25.4 mm	1 1/4" 31.8 mm	1 3/8" 34.9 mm	
8" w.c.	20 mbar	0°				350 (9.80)	450 (12.60)	600 (16.80)	1150 (32.20)	
		40°				210 (5.88)	450 (12.60)	600 (16.80)	900 (25.20)	
10" w.c.	25 mbar	0°				450 (12.60)	1150 (32.20)	1500 (42.00)	1750 (49.00)	
		40°		380 (10.64)	560 (15.68)	250 (7.00)	590 (16.52)	1450 (40.60)	1650 (46.20)	
12" w.c.	30 mbar	0°		510 (14.28)	850 (23.80)	570 (15.96)	1250 (35.00)	1750 (49.00)	2000 (56.00)	
		40°				320 (8.96)	870 (24.36)	1650 (46.20)	2000 (56.00)	
14" w.c.	35 mbar	0°		300 (8.40)	350 (9.80)	650 (18.20)	1650 (46.20)	2100 (58.80)	2600 (72.80)	
		40°			390 (10.92)	370 (10.36)	1500 (42.00)	2050 (57.40)	2200 (61.60)	
16" w.c.	40 mbar	0°		400 (11.20)	450 (12.60)	500 (14.00)	1800 (50.40)	2600 (72.80)	2800 (78.40)	
		40°			320 (8.96)	400 (11.20)	1800 (50.40)	2300 (64.40)	2700 (75.60)	
18" w.c.	45 mbar	0°	290 (8.12)		500 (14.00)	1250 (35.00)	2000 (56.00)	2800 (78.40)	2900 (81.20)	
		40°	270 (7.56)	450 (12.60)	390 (10.92)	1000 (28.00)	2000 (56.00)	2800 (78.40)	2800 (78.40)	
21" w.c.	52 mbar	0°	310 (8.68)	450 (12.60)	720 (20.16)	1500 (42.00)	2500 (70.00)	2900 (81.20)	3300 (92.40)	
		40°	300 (8.40)	620 (17.36)	530 (14.84)	1450 (40.60)	2200 (61.60)	2900 (81.20)	3200 (89.60)	
24" w.c.	60 mbar	0°	370 (10.36)	550 (15.40)	770 (21.56)	1600 (44.80)	2700 (75.60)	3300 (92.40)	3700 (103.60)	
		40°	350 (9.80)	700 (19.60)	650 (18.20)	1030 (28.84)	2700 (75.60)	3100 (86.80)	3300 (92.40)	
1	69 mbar	0°	800 (22.40)	950 (26.60)	1300 (36.40)	1700 (47.60)	2500 (70.00)	3400 (95.20)	3500 (98.00)	
		40°	800 (22.40)	950 (26.60)	1050 (29.40)	1550 (43.40)	2050 (57.40)	2300 (64.40)	2500 (70.00)	
2	0.138	0°	1100 (30.80)	1600 (44.80)	2150 (60.20)	3000 (84.00)	4100 (114.80)	5700 (159.60)	5850 (163.80)	
		40°	1100 (30.80)	1500 (42.00)	1900 (53.20)	2600 (72.80)	3300 (92.40)	3700 (103.60)	4400 (123.20)	
3	0.207	0°	1450 (40.60)	2200 (61.60)	2950 (82.60)	4000 (112.00)	5600 (156.80)	7600 (212.80)	7700 (215.60)	
		40°	1450 (40.60)	2000 (56.00)	2600 (72.80)	3700 (103.60)	4200 (117.60)	5000 (140.00)	5900 (165.20)	
5	0.345	0°	1900 (53.20)	3200 (89.60)	4300 (120.40)	5850 (163.80)	8000 (224.00)	10500 (294.00)	10800 (302.40)	
		40°	1900 (53.20)	2900 (81.20)	3800 (106.40)	5300 (148.40)	5600 (156.80)	6600 (184.80)	9400 (263.20)	
10	0.69	0°	3150 (88.20)	5000 (140.00)	6900 (193.20)	9300 (260.40)	12800 (358.40)	17000 (476.00)	17700 (495.60)	
		40°	3150 (88.20)	4700 (131.60)	6100 (170.80)	8700 (243.60)	9300 (260.40)	9800 (274.40)	14500 (406.00)	
20	1.38	40°	4850 (135.80)	7100 (198.80)	10150 (284.20)	13250 (371.00)	13750 (385.00)	14200 (397.60)	20000 (560.00)	
30	2.07	40°	5500 (154.00)	9000 (252.00)	12000 (336.00)	12000 (336.00)	9000 (252.00)	11000 (308.00)		
40	2.76	40°	7000 (196.00)	11500 (322.00)	15500 (434.00)	16500 (462.00)	10000 (280.00)	20000 (560.00)		
50	3.45	40°	8200 (229.60)	12500 (350.00)	14000 (392.00)	1800 (50.40)	11000 (308.00)			
60	4.14	40°	11000 (308.00)	13400 (375.20)	20000 (560.00)	20000 (560.00)	20000 (560.00)			
70	4.83	40°	10700 (299.60)	14445 (404.46)	20000 (560.00)					
80	5.52	40°	11300 (316.40)	15820 (442.96)						
90	6.21	40°	11210 (313.88)	16520 (462.56)						
100	6.9	40°	17150 (480.20)	20000 (560.00)						
125	8.63	40°	20000 (560.00)	20000 (560.00)						

Change in outlet for a 10 psig (0.69 Bar) inlet change	0.3" wc	0.4" wc	0.6" wc	0.7" wc	1.2" wc	2.0" wc	1.4" wc
Increase in outlet pressure required for no flow	0.3" wc	0.5" wc	1.0" wc	1.1" wc	0.7" wc	1.6" wc	2.2" wc

 Inlet pressure is too low to deliver 7" w.c. (17.5 mbar)  Do not use this orifice size at this inlet pressure  
 Green Spring above line; Brown Spring below line

# B38 Commercial & Industrial Regulator - 7" (17 mbar)

## Typical Performance Curves

Type and Model.....B38 R  
 Regulator:  
 Inlet Size .....2" NPT  
 Outlet Size.....2" NPT  
 Orifice Size .....1/4" x 3/8"  
 Spring .....Green  
 Set Point 7.0" wc with 40 psig inlet @  
 200 scfh. All test results are reported at  
 a base of 14.7 psia and 60 F.

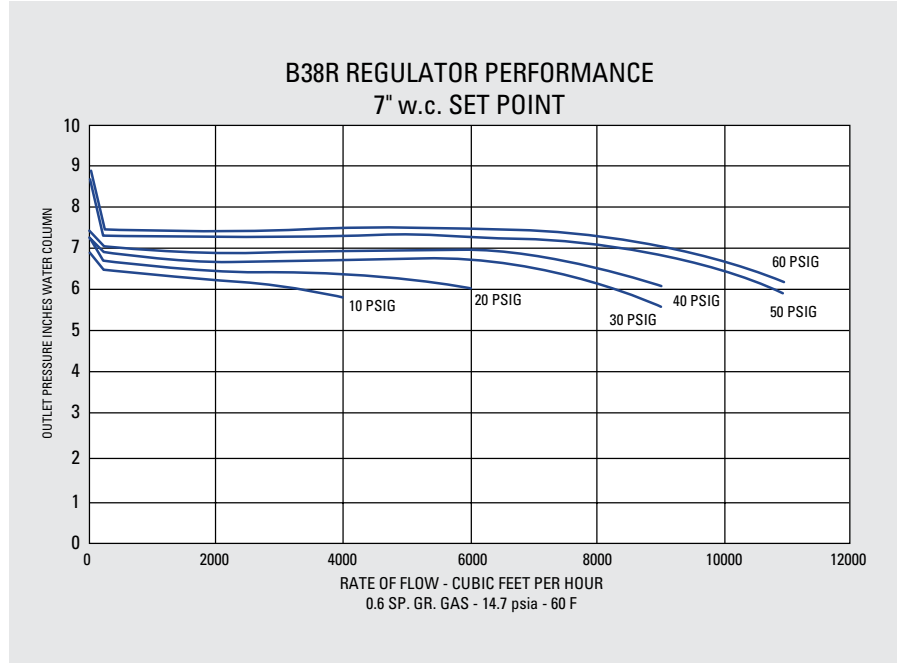

## Relief Characteristic Curves R Model Only

Type and Model.....B38 R  
 Regulator:  
 Inlet Size .....2" NPT  
 Outlet Size.....2" NPT  
 Vent Size .....2-1/2" NPT  
 Set Point 7.0" w.c. with 40 psig inlet @  
 200 scfh. All test results are reported at  
 a base of 14.7 psia and 60 F.

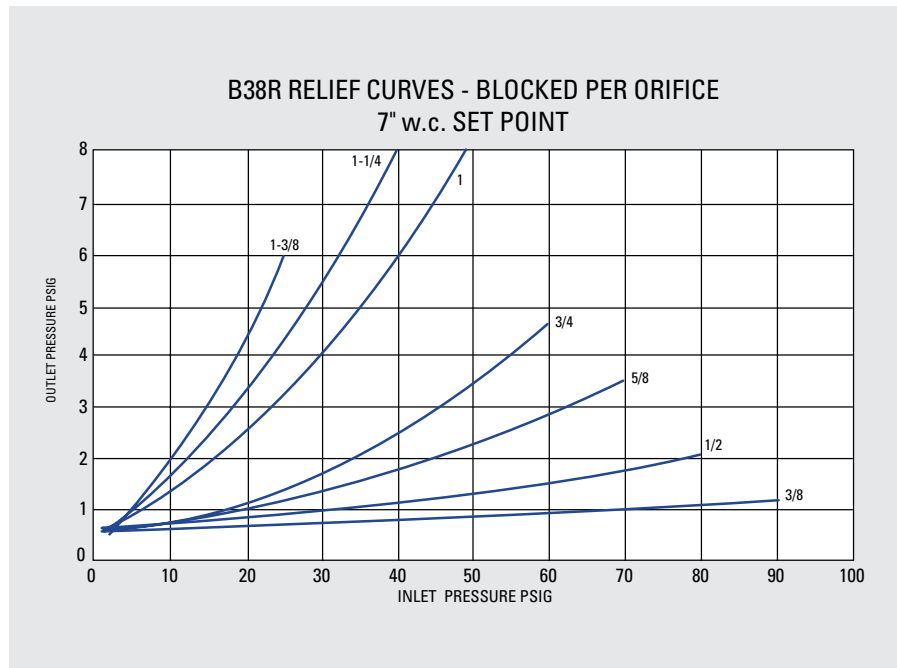

# B38 Commercial & Industrial Regulator - 14" (34 mbar) Capacity Table (2" Droop) – Models N, R, DN, DR, MN, MR

(IM Model Capacity tables located in back section of this document)

Set Point: 14" w.c. (35 mbar) @ 50 scfh (1.42 m<sup>3</sup>/h)

Valve Body: 2" x 2" NPT

Purple Spring - Part No. 762323 Black Spring - Part No.762355

Mounting Position 11

Inlet Pressure		Loading Ring Setting	Capacities in scfh (m <sup>3</sup> /hr) by Orifice Size							
Psig	Bar		3/8" 9.52 mm	1/2" 12.7 mm	5/8" 15.9 mm	3/4" 19.1 mm	1" 25.4 mm	1 1/4" 31.8 mm	1 3/8" 34.9 mm	
16" w.c.	40 mbar	0°		440 (12.32)	575 (16.10)	725 (20.30)	900 (25.20)	900 (25.20)	1350 (37.80)	
		40°		450 (12.60)	450 (12.60)	750 (21.00)	900 (25.20)	1250 (35.00)	1250 (35.00)	
18" w.c.	45 mbar	0°		525 (14.70)	725 (20.30)	850 (23.80)	1200 (33.60)	1400 (39.20)	1700 (47.60)	
		40°		500 (14.00)	600 (16.80)	850 (23.80)	1100 (30.80)	1200 (33.60)	1700 (47.60)	
21" w.c.	52 mbar	0°	230 (6.44)	550 (15.40)	850 (23.80)	1250 (35.00)	1350 (37.80)	1900 (53.20)	2500 (70.00)	
		40°	250 (7.00)	625 (17.50)	750 (21.00)	1050 (29.40)	1350 (37.80)	1700 (47.60)	2450 (68.60)	
24" w.c.	60 mbar	0°	280 (7.84)	625 (17.50)	950 (26.60)	1350 (37.80)	1700 (47.60)	2450 (68.60)	2100 (58.80)	
		40°	260 (7.28)	725 (20.30)	950 (26.60)	1150 (32.20)	1500 (42.00)	2400 (67.20)	2040 (57.12)	
1	69 mbar	0°	325 (9.10)	750 (21.00)	1150 (32.20)	1650 (46.20)	2100 (58.80)	2150 (60.20)	2300 (64.40)	
		40°	300 (8.40)	800 (22.40)	1175 (32.90)	1350 (37.80)	2000 (56.00)	2000 (56.00)	2250 (63.00)	
2	0.138	0°	1000 (28.00)	1400 (39.20)	2100 (58.80)	2500 (70.00)	3100 (86.80)	3500 (98.00)	5000 (140.00)	
		40°	850 (23.80)	1200 (33.60)	1900 (53.20)	2200 (61.60)	2700 (75.60)	3000 (84.00)	3200 (89.60)	
3	0.207	0°	1200 (33.60)	1600 (44.80)	2400 (67.20)	3200 (89.60)	4700 (131.60)	6500 (182.00)	7000 (196.00)	
		40°	1000 (28.00)	1300 (36.40)	2100 (58.80)	2900 (81.20)	3300 (92.40)	5300 (148.40)	5500 (154.00)	
5	0.345	0°	1700 (47.60)	2100 (58.80)	3500 (98.00)	5000 (140.00)	7000 (196.00)	8500 (238.00)	9000 (252.00)	
		40°	1500 (42.00)	1900 (53.20)	3000 (84.00)	3500 (98.00)	5300 (148.40)	5500 (154.00)	6500 (182.00)	
10	0.69	0°	3000 (84.00)	5000 (140.00)	3500 (98.00)	9000 (252.00)	10500 (294.00)	12500 (350.00)	13500 (378.00)	
		40°	3000 (84.00)	4500 (126.00)	6300 (176.40)	7500 (210.00)	8200 (229.60)	9500 (266.00)	8000 (224.00)	
20	1.38	0°	4500 (126.00)	8000 (224.00)	10500 (294.00)	13500 (378.00)	15500 (434.00)	19000 (532.00)	20000 (560.00)	
		40°	4500 (126.00)	7500 (210.00)	10000 (280.00)	10000 (280.00)	11000 (308.00)	11500 (322.00)	6000 (168.00)	
30	2.07	0°	6500 (182.00)	10500 (294.00)	14000 (392.00)	17500 (490.00)	20000 (560.00)	20000 (560.00)		
		40°	6500 (182.00)	9000 (252.00)	12000 (336.00)	11500 (322.00)	11500 (322.00)	8000 (224.00)		
40	2.76	0°	7600 (212.80)	13000 (364.00)	18500 (518.00)	20000 (560.00)	20000 (560.00)	20000 (560.00)		
		40°	7600 (212.80)	10000 (280.00)	13000 (364.00)	12000 (336.00)	11500 (322.00)	8500 (238.00)		
50	3.45	0°	9000 (252.00)	15000 (420.00)	20000 (560.00)	20000 (560.00)	20000 (560.00)	20000 (560.00)		
		40°	9000 (252.00)	11500 (322.00)	13500 (378.00)	12500 (350.00)	11000 (308.00)	10000 (280.00)		
60	4.14	0°	10500 (294.00)	17500 (490.00)	20000 (560.00)	20000 (560.00)	20000 (560.00)	20000 (560.00)		
		40°	10500 (294.00)	12200 (341.60)	14200 (397.60)	12500 (350.00)	11000 (308.00)	11000 (308.00)		
70	4.83	40°	11770 (329.56)	12840 (359.52)	14935 (418.18)	14125 (395.50)				
80	5.52	40°	12995 (363.86)	14125 (395.50)	16950 (474.60)					
90	6.21	40°	14160 (396.48)	15340 (429.52)	17700 (495.60)					
100	6.9	40°	15480 (438)	16920 (478)	18500 (523)					
125	8.63	40°	13860 (392)	20600 (583)	22500 (637)					

Change in outlet for a 10 psig (0.69 Bar) inlet change	0.3" wc	0.4" wc	0.55" wc	0.8" wc	1.7" wc	1.8" wc	2.0" wc
Increase in outlet pressure required for no flow	.7" wc	1.4" wc	1.9" wc	2.0" wc	2.6" wc	2.9" wc	3.1" wc

 Inlet pressure is too low to deliver 14" w.c. (35mbar)

 Do not use this orifice size at this inlet pressure

 Purple Spring above line; Black Spring below line

# B38 Commercial & Industrial Regulator - 14" (34 mbar)

## Typical Performance Curves

Type and Model.....B38 R

Regulator:

Inlet Size .....2" NPT

Outlet Size.....2" NPT

Orifice Size .....1/4" x 3/8"

Spring .....Green

Set Point 14.0" wc with 40 psig inlet @ 200 scfh. All test results are reported at a base of 14.7 psia and 60 F.

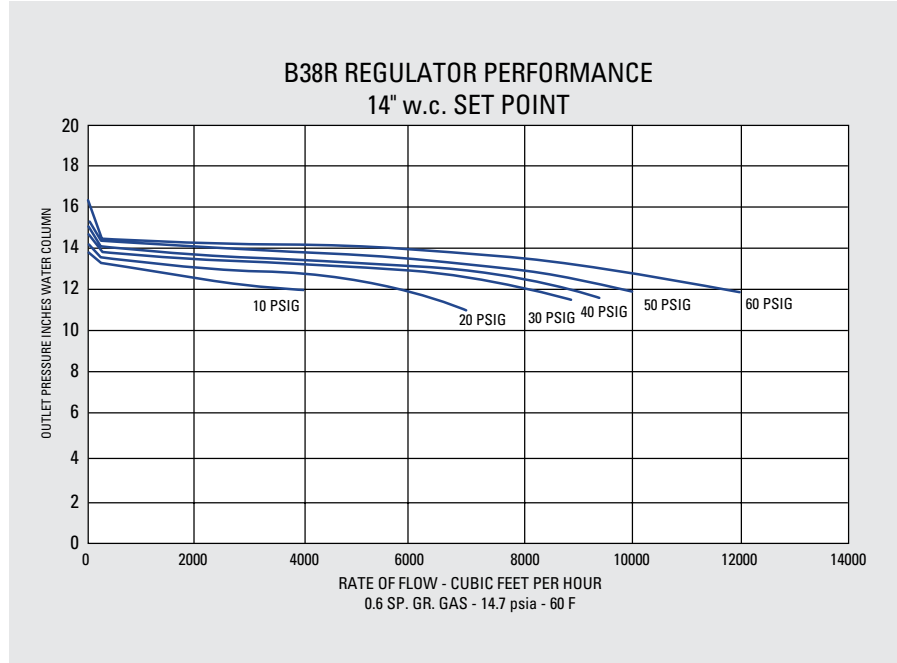

## Relief Characteristic Curves R Model Only

Type and Model.....B38 R

Regulator:

Inlet Size .....2" NPT

Outlet Size.....2" NPT

Vent Size .....2-1/2" NPT

Set Point 14.0" w.c. with 40 psig inlet @ 200 scfh. All test results are reported at a base of 14.7 psia and 60 F.

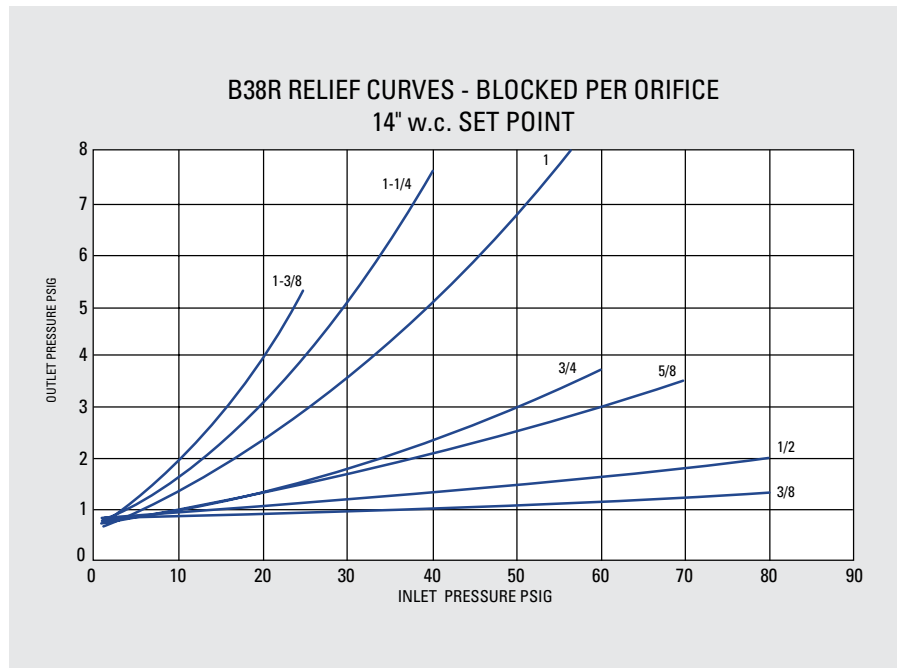

# B38 Commercial & Industrial Regulator - 1 psig (69 mbar) Capacity Table (1% absolute Droop) – Models N, R, DN, DR, MN, MR

(IM Model Capacity tables located in back section of this document)

Set Point: 1 psig (69 mbar) @ 200 scfh (5.68 m<sup>3</sup>/h)  
Blue/White Spring - Part No. 762358

2" X 2" NPT Valve Body  
Mounting Position 11

Inlet Pressure		Loading Ring Setting	Capacities in scfh (m <sup>3</sup> /hr) by Orifice Size							
Psig	Bar		3/8" 9.52 mm	1/2" 12.7 mm	5/8" 15.9 mm	3/4" 19.1 mm	1" 25.4 mm	1 1/4" 31.8 mm	1 3/8" 34.9 mm	
2	0.138	0°	800 (22.40)	1300 (36.40)	1650 (46.20)	2300 (64.40)	2700 (75.60)	3300 (92.40)	4200 (117.60)	
3	0.207	0°	1150 (32.20)	1700 (47.60)	2200 (61.60)	3300 (92.40)	4000 (112.00)	4350 (121.80)	5000 (140.00)	
5	0.345	0°	1700 (47.60)	2400 (67.20)	3150 (88.20)	4500 (126.00)	5200 (145.60)	6500 (182.00)	7500 (210.00)	
10	0.69	0°	2500 (70.00)	4000 (112.00)	6000 (168.00)	6500 (182.00)	8500 (238.00)	11000 (308.00)	11200 (313.60)	
20	1.38	0°	4300 (120.40)	7000 (196.00)	9000 (252.00)	11000 (308.00)	14000 (392.00)	17000 (476.00)	20000 (560.00)	
30	2.07	0°	6200 (173.60)	9400 (263.20)	12500 (350.00)	14500 (406.00)	18500 (518.00)	20000 (560.00)		
40	2.76	0°	7500 (210.00)	12000 (336.00)	15000 (420.00)	19000 (532.00)	20000 (560.00)	20000 (560.00)		
50	3.45	0°	8500 (238.00)	14000 (392.00)	20000 (560.00)	20000 (560.00)	20000 (560.00)			
60	4.14	0°	10500 (294.00)	15500 (434.00)	20000 (560.00)	20000 (560.00)	20000 (560.00)			
70	4.83	0°	11330 (317.24)	19795 (554.26)	20000 (560.00)					
80	5.52	0°	12995 (363.86)	20000 (560.00)						
90	6.21	0°	14160 (396.48)	20000 (560.00)						
100	6.9	0°	15200 (430.00)	20000 (560.00)						
125	8.63	0°	17100 (483.00)	20000 (560.00)						

# B38 Commercial & Industrial Regulator - 1 psig (69 mbar) Capacity Table (2% absolute Droop) – Models N, R, DN, DR, MN, MR

(IM Model Capacity tables located in back section of this document)

Set Point: 1 psig (69 mbar) @ 200 scfh (5.68 m<sup>3</sup>/h)  
Blue/White Spring - Part No. 762358

2" X 2" NPT Valve Body  
Mounting Position 11

Inlet Pressure		Loading Ring Setting	Capacities in scfh (m <sup>3</sup> /hr) by Orifice Size							
Psig	Bar		3/8" 9.52 mm	1/2" 12.7 mm	5/8" 15.9 mm	3/4" 19.1 mm	1" 25.4 mm	1 1/4" 31.8 mm	1 3/8" 34.9 mm	
2	0.138	0°	1070 (29.96)	1400 (39.20)	2100 (58.80)	3200 (89.60)	4300 (120.40)	5000 (140.00)	6200 (173.60)	
3	0.207	0°	1450 (40.60)	2200 (61.60)	3050 (85.40)	4000 (112.00)	5250 147.00	6400 179.20	7500 (210.00)	
5	0.345	0°	2200 (61.60)	3200 (89.60)	4400 (123.20)	6300 (176.40)	8000 224.00	10000 280.00	10500 (294.00)	
10	0.69	0°	3100 (86.80)	4200 (117.60)	7500 (210.00)	9000 (252.00)	11500 322.00	14700 411.60	14500 (406.00)	
20	1.38	0°	4700 (131.60)	8000 (224.00)	11500 (322.00)	14000 (392.00)	18000 504.00	20000 560.00	20000 (560.00)	
30	2.07	0°	6400 (179.20)	10500 (294.00)	15000 (420.00)	18500 (518.00)	20000 560.00	20000 560.00		
40	2.76	0°	7500 (210.00)	13000 (364.00)	18500 (518.00)	20000 (560.00)	20000 560.00	20000 560.00		
50	3.45	0°	8800 (246.40)	15500 (434.00)	20000 (560.00)	20000 (560.00)	20000 560.00			
60	4.14	0°	10500 (294.00)	17500 (490.00)	20000 (560.00)	20000 (560.00)	20000 560.00			
70	4.83	0°	11330 (317.24)	18500 (518.00)	20000 (560.00)					
80	5.52	0°	12995 (363.86)	20000 (560.00)						
90	6.21	0°	14160 (396.48)	20000 (560.00)						
100	6.9	0°	15200 (430.00)	20000 (560.00)						
125	8.63	0°	17100 (483.00)	20000 (560.00)						

Change in outlet for a 10 psig (0.69 Bar) inlet change	0.01 psig	0.04 psig	0.02 psig	0.03 psig	0.06 psig	0.08 psig	0.11 psig
Increase in outlet pressure required for no flow	0.06 psig	0.05 psig	0.06 psig	0.07 psig	0.11 psig	0.13 psig	0.15 psig

Do not use this orifice size at this inlet pressure

# B38 Commercial & Industrial Regulator - 1 psig (69 mbar)

## Typical Performance Curves

Type and Model.....B38 R

Regulator:

Inlet Size .....2" NPT

Outlet Size.....2" NPT

Orifice Size .....1/4" x 3/8"

Spring .....Green

Set Point 1.0 psig with 40 psig inlet @ 200 scfh. All test results are reported at a base of 14.7 psia and 60 F.

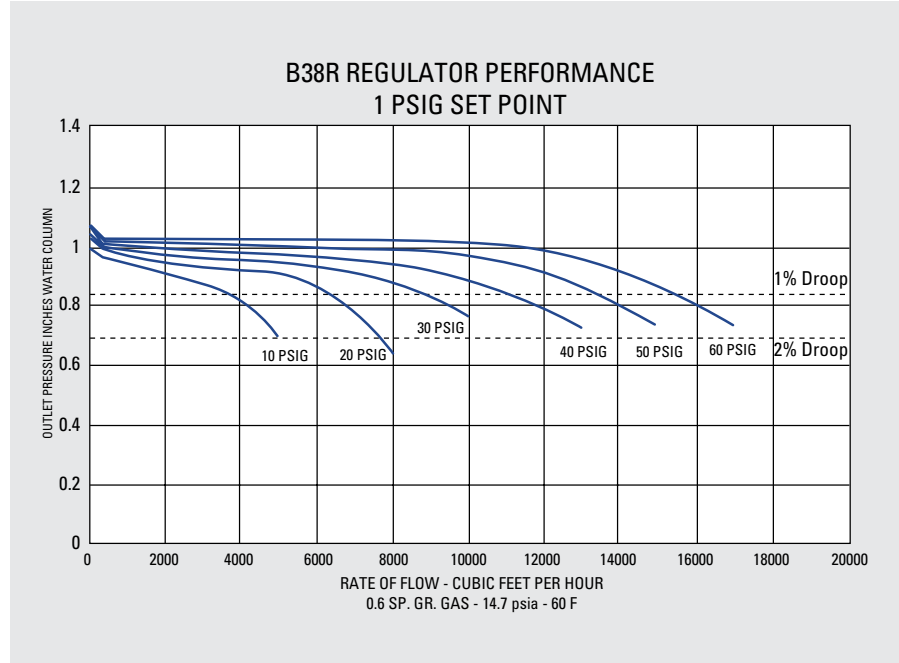

## Relief Characteristic Curves R Model Only

Type and Model.....B38 R

Regulator:

Inlet Size .....2" NPT

Outlet Size.....2" NPT

Vent Size .....2-1/2" NPT

Set Point 1.0 psig with 40 psig inlet @ 200 scfh. All test results are reported at a base of 14.7 psia and 60 F.

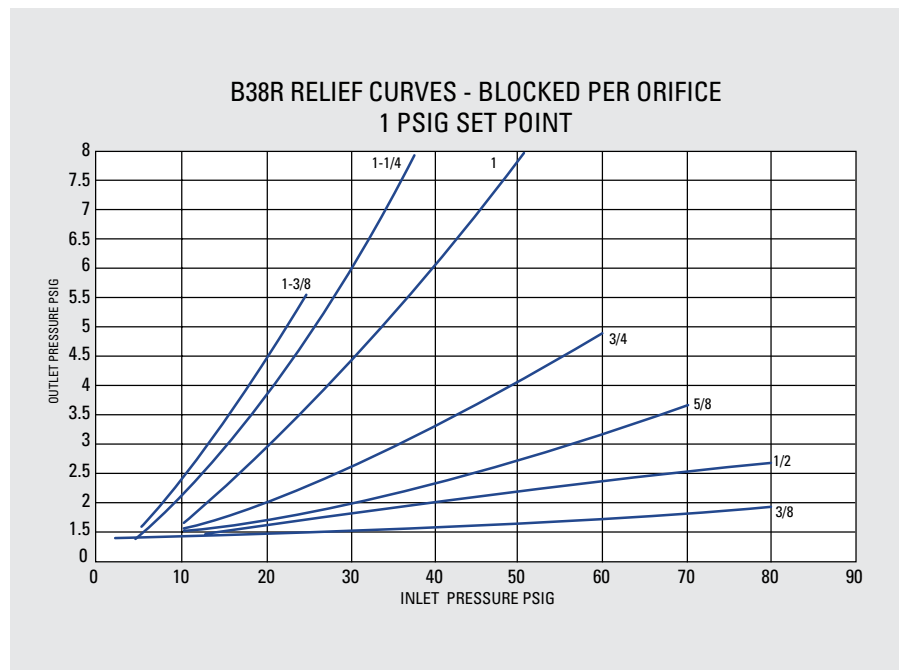

# B38 Commercial & Industrial Regulator - 2 psig (138 mbar) Capacity Table (1% absolute Droop) – Models N, R, DN, DR, MN, MR

(IM Model Capacity tables located in back section of this document)

Set Point: 2 psig (138 mbar) @ 200 scfh (5.68 m<sup>3</sup>/h)  
Silver Spring - Part No. 762359

2" x 2" NPT Valve Body  
Mounting Position 11

Inlet Pressure		Loading Ring Setting	Capacities in scfh (m <sup>3</sup> /hr) by Orifice Size							
Psig	Bar		3/8" 9.52 mm	1/2" 12.7 mm	5/8" 15.9 mm	3/4" 19.1 mm	1" 25.4 mm	1 1/4" 31.8 mm	1 3/8" 34.9 mm	
3	0.207	0°	850 (23.80)	700 (19.60)	800 (22.40)	1200 (33.60)	1600 (44.80)	1750 (49.00)	2050 (57.40)	
5	0.345	0°	1350 (37.80)	1200 (33.60)	1450 (40.60)	1650 (46.20)	2300 (64.40)	2850 (79.80)	3100 (86.80)	
10	0.69	0°	1500 (42.00)	1900 (53.20)	2500 (70.00)	3100 (86.80)	4800 (134.40)	5800 (162.40)	6300 (176.40)	
20	1.38	0°	2700 (75.60)	3000 (84.00)	3700 (103.60)	7200 (201.60)	9000 (252.00)	10500 (294.00)	11500 (322.00)	
30	2.07	0°	3800 (106.40)	4700 (131.60)	7500 (210.00)	10200 (285.60)	12500 (350.00)	16000 (448.00)		
40	2.76	0°	5300 (148.40)	8000 (224.00)	9800 (274.40)	13500 (378.00)	17500 (490.00)	20000 (560.00)		
50	3.45	0°	7000 (196.00)	10000 (280.00)	13000 (364.00)	14500 (406.00)	20000 (560.00)			
60	4.14	0°	9000 (252.00)	14500 (406.00)	16300 (456.40)	20000 (560.00)	20000 (560.00)			
70	4.83	0°	10300 (288.40)	13390 (374.92)	20000 (560.00)					
80	5.52	0°	11865 (332.22)	15594 (436.63)						
90	6.21	0°	13216 (370.05)	16756 (469.17)						
100	6.9	0°	16500 (462.00)	20000 (560.00)						
125	8.63	0°	19600 (548.80)	20000 (560.00)						

# B38 Commercial & Industrial Regulator - 2 psig (138 mbar) Capacity Table (2% absolute Droop) – Models N, R, DN, DR, MN, MR

(IM Model Capacity tables located in back section of this document)

Set Point: 2 psig (138 mbar) @ 200 scfh (5.68 m<sup>3</sup>/h)  
Silver Spring - Part No. 762359

2" x 2" NPT Valve Body  
Mounting Position 11

Inlet Pressure		Loading Ring Setting	Capacities in scfh (m <sup>3</sup> /hr) by Orifice Size							
Psig	Bar		3/8" 9.52 mm	1/2" 12.7 mm	5/8" 15.9 mm	3/4" 19.1 mm	1" 25.4 mm	1 1/4" 31.8 mm	1 3/8" 34.9 mm	
3	0.207	0°	1200 (33.60)	1200 (33.60)	1550 (43.40)	2000 (56.00)	3250 (91.00)	3400 (95.20)	3975 (111.30)	
5	0.345	0°	1650 (46.20)	2050 (57.40)	2500 (70.00)	3300 (92.40)	4450 (124.60)	5800 (162.40)	6350 (177.80)	
10	0.69	0°	2400 (67.20)	3700 (103.60)	4800 (134.40)	6100 (170.80)	8000 (224.00)	10200 (285.60)	11500 (322.00)	
20	1.38	0°	4200 (117.60)	5100 (142.80)	8000 (224.00)	11000 (308.00)	13000 (364.00)	15500 (434.00)	18500 (518.00)	
30	2.07	0°	5700 (159.60)	8500 (238.00)	10500 (294.00)	14200 (397.60)	17500 (490.00)	20000 (560.00)		
40	2.76	0°	7000 (196.00)	10500 (294.00)	13500 (378.00)	18500 (518.00)	20000 (560.00)	20000 (560.00)		
50	3.45	0°	8800 (246.40)	12500 (350.00)	16000 (448.00)	20000 (560.00)	20000 (560.00)			
60	4.14	0°	9700 (271.60)	16500 (462.00)	20000 (560.00)	20000 (560.00)	20000 (560.00)			
70	4.83	0°	11330 (317.24)	15965 (447.02)	20000 (560.00)					
80	5.52	0°	13108 (367.02)	19210 (537.88)						
90	6.21	0°	14160 (396.48)	21830 (611.24)						
100	6.9	0°	17000 (476.00)	20000 (560.00)						
125	8.63	0°	20000 (560.00)	20000 (560.00)						

Change in outlet for a 10 psig (0.69 Bar) inlet change	0.01 psig	0.04 psig	0.06 psig	0.03 psig	0.07 psig	0.12 psig	0.13 psig
Increase in outlet pressure required for no flow	0.05 psig	0.05 psig	0.06 psig	0.06 psig	0.08 psig	0.09 psig	0.11 psig

Do not use this orifice size at this inlet pressure

# B38 Commercial & Industrial Regulator - 2 psig (138 mbar)

## Typical Performance Curves

Type and Model.....B38 R  
 Regulator:  
 Inlet Size .....2" NPT  
 Outlet Size.....2" NPT  
 Orifice Size .....1/4" x 3/8"  
 Spring .....Green  
 Set Point 2.0 psig with 40 psig inlet @  
 200 scfh. All test results are reported at  
 a base of 14.7 psia and 60 F.

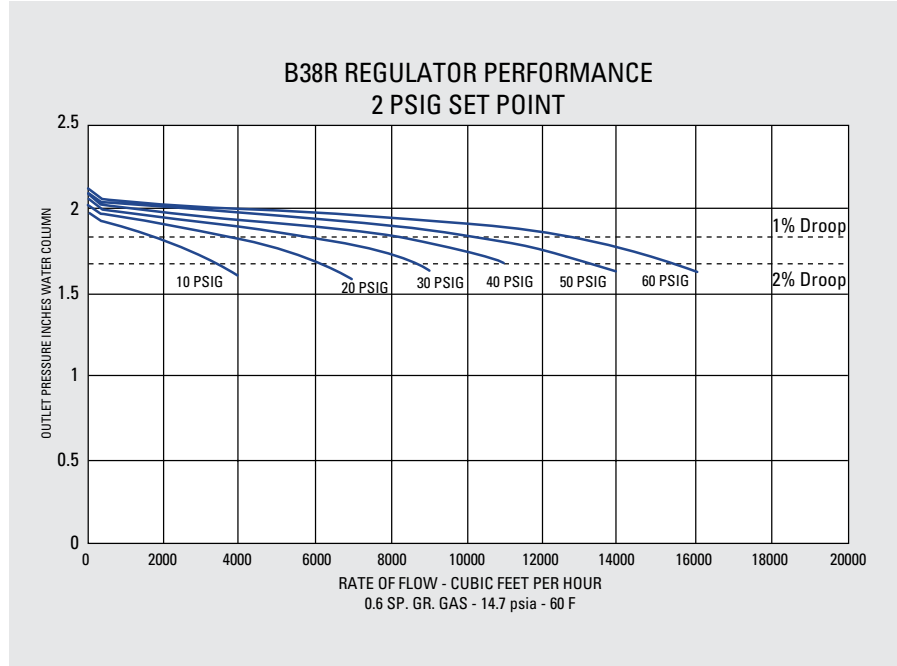

## Relief Characteristic Curves R Model Only

Type and Model.....B38 R  
 Regulator:  
 Inlet Size .....2" NPT  
 Outlet Size.....2" NPT  
 Vent Size .....2-1/2" NPT  
 Set Point 2.0 psig with 40 psig inlet @  
 200 scfh. All test results are reported at  
 a base of 14.7 psia and 60 F.

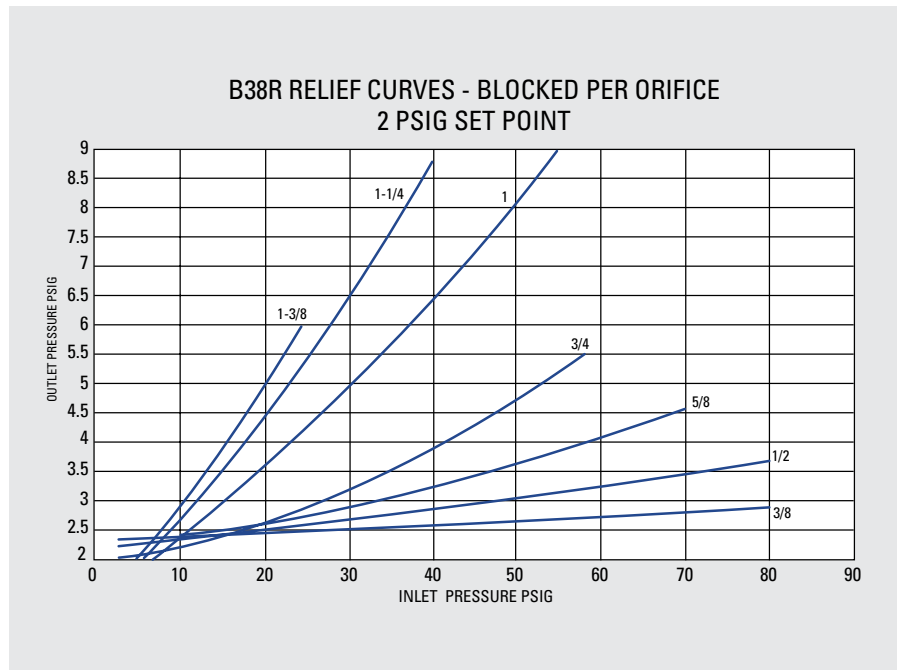

# B38 Commercial & Industrial Regulator - 5 psig (345 mbar) Capacity Table (1% absolute Droop) – Models N, R, DN, DR, MN, MR

(IM Model Capacity tables located in back section of this document)

Set Point: 5 psig (345 mbar) @ 200 scfh (5.68 m<sup>3</sup>/h)  
Red Nested Spring - Part No. 762671

2" x 2" NPT Valve Body  
Mounting Position 11

Inlet Pressure		Loading Ring Setting	Capacities in scfh (m <sup>3</sup> /hr) by Orifice Size							
Psig	Bar		3/8" 9.52 mm	1/2" 12.7 mm	5/8" 15.9 mm	3/4" 19.1 mm	1" 25.4 mm	1 1/4" 31.8 mm	1 3/8" 34.9 mm	
10	0.69	0°	500 (14.00)	950 (26.60)	1000 (28.00)	1250 (35.00)	1500 (42.00)	2000 (56.00)	2250 (63.00)	
20	1.38	0°	1000 (28.00)	1000 (28.00)	1400 (39.20)	1700 (47.60)	2000 (56.00)	2000 (56.00)	2500 (70.00)	
30	2.07	0°	1100 (30.80)	1150 (32.20)	1800 (50.40)	2400 (67.20)	2800 (78.40)	2500 (70.00)		
40	2.76	0°	1500 (42.00)	1300 (36.40)	2300 (64.40)	2700 (75.60)	3600 (100.80)	6200 (173.60)		
50	3.45	0°	1700 (47.60)	1600 (44.80)	2800 (78.40)	3300 (92.40)	3700 (103.60)			
60	4.14	0°	3200 (89.60)	3650 (102.20)	5800 (162.40)	7000 (196.00)	10000 (280.00)			
70	4.83	0°	2369 (66.33)	2060 (57.68)	3399 (95.17)					
80	5.52	0°	2825 (79.10)	3277 (91.76)						
90	6.21	0°	2832 (79.30)	3422 (95.82)						
100	6.9	0°	5800 (162.40)	7900 (221.20)						
125	8.63	0°	7000 (196.00)	10800 (302.40)						

# B38 Commercial & Industrial Regulator - 5 psig (345 mbar) Capacity Table (2% absolute Droop) – Models N, R, DN, DR, MN, MR

(IM Model Capacity tables located in back section of this document)

Set Point: 5 psig (345 mbar) @ 200 scfh (5.68 m<sup>3</sup>/h)  
Red Nested Spring - Part No. 762671

2" x 2" NPT Valve Body  
Mounting Position 11

Inlet Pressure		Loading Ring Setting	Capacities in scfh (m <sup>3</sup> /hr) by Orifice Size							
Psig	Bar		3/8" 9.52 mm	1/2" 12.7 mm	5/8" 15.9 mm	3/4" 19.1 mm	1" 25.4 mm	1 1/4" 31.8 mm	1 3/8" 34.9 mm	
10	0.69	0°	900 (25.20)	1750 (49.00)	2000 (56.00)	2500 (70.00)	2500 (70.00)	3500 (98.00)	4000 (112.00)	
20	1.38	0°	1200 (33.60)	1800 (50.40)	2700 (75.60)	3300 (92.40)	4000 (112.00)	4500 (126.00)	5200 (145.60)	
30	2.07	0°	2300 (64.40)	2400 (67.20)	3600 (100.80)	5100 (142.80)	6200 (173.60)	7000 (196.00)		
40	2.76	0°	2800 (78.40)	3000 (84.00)	4100 (114.80)	6500 (182.00)	8000 (224.00)	8500 (238.00)		
50	3.45	0°	3500 (98.00)	3700 (103.60)	6000 (168.00)	8500 (238.00)	9000 (252.00)			
60	4.14	0°	6000 (168.00)	7500 (210.00)	9800 (274.40)	11500 (322.00)	15000 (420.00)			
70	4.83	0°	4429 (124.01)	4635 (129.78)	8446 (236.49)					
80	5.52	0°	5311 (148.71)	7458 (208.82)						
90	6.21	0°	5664 (158.59)	7552 (211.46)						
100	6.9	0°	8500 (238.00)	13000 (364.00)						
125	8.63	0°	10300 (288.40)	16700 (467.60)						

Change in outlet for a 10 psig (0.69 Bar) inlet change	0.03 psig	0.05 psig	0.05 psig	0.10 psig	0.13 psig	0.19 psig	0.23 psig
Increase in outlet pressure required for no flow	0.08 psig	0.11 psig	0.11 psig	0.11 psig	0.18 psig	0.2 psig	0.22 psig

Do not use this orifice size at this inlet pressure

# B38 Commercial & Industrial Regulator - 5 psig (345 mbar)

## Typical Performance Curves

Type and Model.....B38 R  
 Regulator:  
 Inlet Size .....2" NPT  
 Outlet Size.....2" NPT  
 Orifice Size .....1/4" x 3/8"  
 Spring .....Green  
 Set Point 5.0 psig with 40 psig inlet @  
 200 scfh. All test results are reported at  
 a base of 14.7 psia and 60 F.

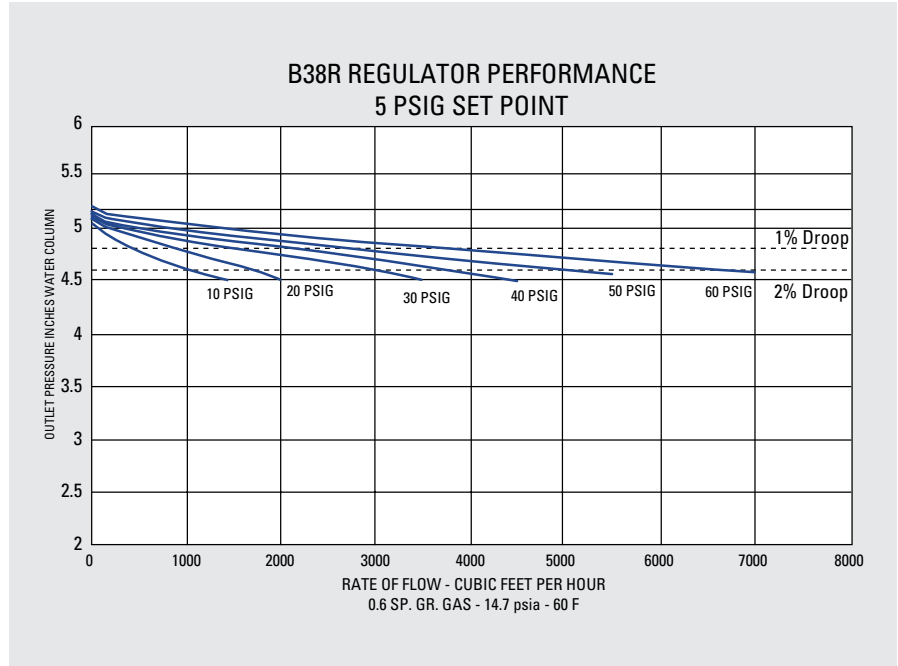

## Relief Characteristic Curves R Model Only

Type and Model.....B38 R  
 Regulator:  
 Inlet Size .....2" NPT  
 Outlet Size.....2" NPT  
 Vent Size .....2-1/2" NPT  
 Set Point 5.0 psig with 40 psig inlet @  
 200 scfh. All test results are reported at  
 a base of 14.7 psia and 60 F.

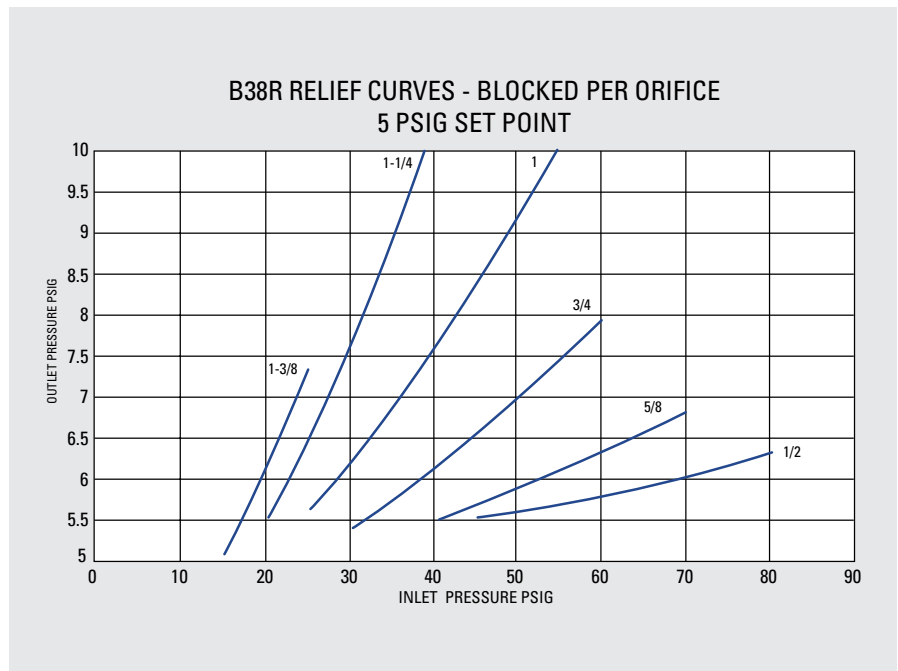

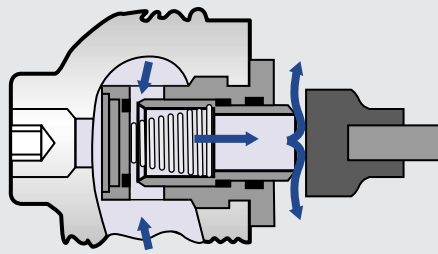

A. Standard Regulator and upstream monitor orifice

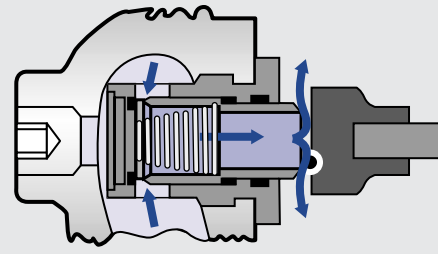

B. Standard Regulator orifice failed; upstream monitor orifice control

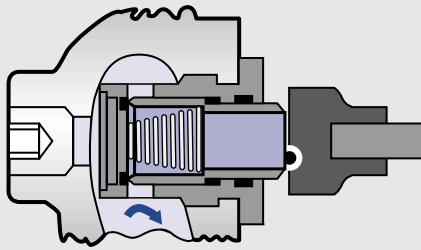

C. Main orifice failed - upstream monitor orifice "lock-up"

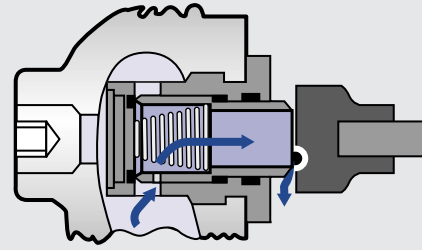

D. "V" Option - Vents small volume of gas to atmosphere through relief valve

□ inlet pressure    ■ outlet pressure

### Internal Monitor Principle of Operation

- A. The internal monitor (IM) orifice performs like a standard regulator and monitor orifice in that the monitor orifice is wide open under normal operation and the regulating orifice and valve seat actuate to control outlet flow and pressure. The regulator is free to lock-up in the usual manner, with pressure increase to position the valve seat "bubble" tight against the regulating orifice face. However, both the monitor seat and the regulator seat may close together if the positive shock lock-up exceeds the monitor spring setting.
- B. If the main valve seat fails to control the gas flow and pressure due to foreign matter between the seat and orifice face, or if the seat is eroded, the internal monitor orifice automatically goes into

operating position at a slightly higher outlet pressure (SEE INTERNAL MONITOR LOCK-UP AND RELIEF PRESSURE TABLE ON PAGE 16). Any time the pressure on the large main diaphragm exceeds the force of the fixed monitor spring and the adjusted pressure of the main spring, this increase in outlet pressure causes the main valve seat to push against the sliding orifice, compressing the monitor spring and positions the monitor orifice to control the gas flow. The IM orifice now functions as a monitor regulator and will continue to monitor so long as the main seats fails to control at the normal adjusted outlet pressure. However, if the gas load demand is increased beyond the Internal Monitor's capacity, the outlet pressure is reduced to normal adjusted pressure and the regulator resumes normal regulation.

- C. However, if the demand for gas is decreased to zero flow during monitor operation, the sliding orifice continues to close until its orifice is in the gas tight position (monitor lock-up) against the BUNA-N monitor valve seat. Outlet pressure required for Internal Monitor "lock-up" is shown in Internal Monitor Lock-Up Table on Page 16.
- D. On installations where a small volume of over-pressure gas can be safely vented to atmosphere, the advantage of both relief valve and monitor safety can be combined. The monitor to hold overpressure buildup to a low-pressure increase, and relief gas vented to atmosphere to indicate that the main valve has failed and the regulator is on monitor operation.

<b>Spring Range Data – Models B38IMN, B38IMR</b>				
ADJUSTED OUTLET PRESSURE RANGE				
SPRING ADJUSTMENT FERRULE AT MIN. AND MAX. DEPTHS				
Orifice Size	Inlet Pressure	Spring Color	Outlet Pressure	
			Min.	Max
3/8"	25 PSIG	Orange	2.8" W.C.	4.1" W.C.
		Brown	4.2" W.C.	6.9" W.C.
		Green	5.3" W.C.	8.1" W.C.
		Black	7.0" W.C.	12.6" W.C.
		Blue/Wht	0.50 PSIG	1.02 PSIG
		Silver/Red	1.21 PSIG	2.06 PSIG
		Yellow	1.57 PSIG	3.56 PSIG
		Red	2.23 PSIG	5.03 PSIG*
1/2"	25 PSIG	Orange	2.8" W.C.	4.2" W.C.
		Brown	4.2" W.C.	7.0" W.C.
		Green	5.3" W.C.	8.2" W.C.
		Black	7.2" W.C.	12.9" W.C.
		Blue/Wht	0.51 PSIG	1.0 PSIG
		Silver/Red	1.21 PSIG	2.6 PSIG
		Yellow	1.57 PSIG	3.64 PSIG
		Red	2.26 PSIG	5.03 PSIG*
5/8"	25 PSIG	Orange	3.3" W.C.	4.6" W.C.
		Brown	4.6" W.C.	7.3" W.C.
		Green	6.1" W.C.	8.7" W.C.
		Black	8.1" W.C.	13.6" W.C.
		Blue/Wht	0.57 PSIG	1.05 PSIG
		Silver/Red	1.29 PSIG	2.19 PSIG
		Yellow	1.78 PSIG	3.88 PSIG
		Red	2.48 PSIG	5.18 PSIG*
3/4"	25 PSIG	Orange	3.6" W.C.	4.8" W.C.
		Brown	5.2" W.C.	7.8" W.C.
		Green	6.6" W.C.	9.2" W.C.
		Black	8.2" W.C.	14.1" W.C.
		Blue/Wht	0.57 PSIG	1.07 PSIG
		Silver/Red	1.31 PSIG	2.23 PSIG
		Yellow	1.77 PSIG	3.79 PSIG
		Red	2.47 PSIG	5.13 PSIG*
1"	10 PSIG	Orange	3.3" W.C.	4.9" W.C.
		Brown	5.1" W.C.	7.7" W.C.
		Green	6.2" W.C.	8.8" W.C.
		Black	8.3" W.C.	13.95" W.C.
		Blue/Wht	0.57 PSIG	1.07 PSIG
		Silver/Red	1.28 PSIG	2.24 PSIG
		Yellow	1.73 PSIG	3.80 PSIG
		Red	2.44 PSIG	5.06 PSIG*

\* Maximum allowable pressure is 5.00 PSIG

INTERNAL MONITOR LOCK-UP AND RELIEF PRESSURE DATA			
Main Spring Color	Outlet Pressure Set Point	IM Lock-up Pressure Models B38IMN & IMR	Relief Pressure Model B38IMRV
BROWN	5.5" w.c.	11.0" w.c.	15.0" w.c.
BROWN N Models	7.0 w.c.	12.5" w.c.	17.0" w.c.
GREEN R Models	7.0" w.c.	12.5" w.c.	17.0" w.c.
BLACK	11.0" w.c.	19.0" w.c.	22.5" w.c.
BLACK	14.0" w.c.	23.5" w.c.	29.5" w.c.
BLUE/WHT	1 psig	1.5 psig	1.9 psig
SILVER/RED	2 psig	3.0 psig	3.8 psig
YELLOW	3 psig	4.0 psig	5.0 psig
RED NESTED	5 psig	6.2 psig	8.4 psig

OUTLET PRESSURE CHANGE AS A RESULT OF A 10 PSIG INLET PRESSURE CHANGE					
ORIFICE SIZE - INCHES					
SPRING COLOR	3/8"	1/2"	5/8"	3/4"	1"
ORANGE	0.11" W.C.	0.22" W.C.	0.32" W.C.	0.47" W.C.	0.86" W.C.
BROWN	0.13" W.C.	0.23" W.C.	0.40" W.C.	0.50" W.C.	0.95" W.C.
GREEN	0.17" W.C.	0.23" W.C.	0.40" W.C.	0.50" W.C.	1.00" W.C.
BLACK	0.17" W.C.	0.23" W.C.	0.42" W.C.	0.50" W.C.	1.00" W.C.
BLUE/WHT	0.01 PSIG	0.01 PSIG	0.02 PSIG	0.02 PSIG	0.04 PSIG
SILVER/RED	0.01 PSIG	0.01 PSIG	0.02 PSIG	0.02 PSIG	0.05 PSIG
YELLOW	0.01 PSIG	0.02 PSIG	0.02 PSIG	0.03 PSIG	0.06 PSIG
RED	0.01 PSIG	0.02 PSIG	0.02 PSIG	0.03 PSIG	0.07 PSIG

# B38 Commercial & Industrial Regulator - 7" (17 mbar) Capacity Table (1" Droop) – Models IMN, IMR, IMRV

Set Point: 7" w.c. ( mbar) @ 200 scfh (5.68 m³/h)  
2" x 2" NPT Valve Body

Loading Ring Setting: 27 degrees  
Green Spring-Part No. 762353

Mounting Position 11

Inlet Pressure		Capacities in scfh (m³/hr) by Orifice Size									
		3/8" 9.52 mm		1/2" 12.7 mm		5/8" 15.9 mm		3/4" 19.1 mm		1" 25.4 mm	
Psig	Bar										
1	0.07	400	(11.20)	650	(18.20)	1000	(28.00)	1200	(33.60)	1600	(44.80)
2	0.14	750	(21.00)	1150	(32.20)	2100	(58.80)	2300	(64.40)	3000	(84.00)
3	0.21	1000	(28.00)	1650	(46.20)	2800	(78.40)	3000	(84.00)	4000	(112.00)
5	0.35	1500	(42.00)	2200	(61.60)	3800	(106.40)	4600	(128.80)	5300	(148.40)
10	0.69	2400	(67.20)	3600	(100.80)	6100	(170.80)	6900	(193.20)	8800	(246.40)
15	1.03	3200	(89.60)	5000	(140.00)	8300	(232.40)	8400	(235.20)	10500	(294.00)
20	1.38	4400	(123.20)	6000	(168.00)	9500	(266.00)	10750	(301.00)	12000	(336.00)
25	1.72	5000	(140.00)	6700	(187.60)	11500	(322.00)	14300	(400.40)	15000	(420.00)
30	2.07	5500	(154.00)	7000	(196.00)	12500	(350.00)	14800	(414.40)	17000	(476.00)
40	2.76	7000	(196.00)	8000	(224.00)	14500	(406.00)	15000	(420.00)		
50	3.45	8000	(224.00)	8200	(229.60)	15000	(420.00)	16000	(448.00)		
60	4.14	8900	(249.20)	8560	(239.00)	20000	(560.00)	20000	(560.00)		
70	4.83	9630	(269.64)	9095	(254.66)						
75	5.17	9850	(285.00)	10500	(294.00)						
80	5.52	10170	(284.76)	12000	(336.00)						
90	6.21	10325	(289.10)	16000	(448.00)						
95	6.55	13500	(378.00)	20000	(560.00)						
100	6.90	15470	(433.16)	20000	(560.00)						
125	8.63	17000	(476.00)	20000	(560.00)						

Change in outlet for a 10 psig (0.69 Bar) inlet change	.17" w.c.	.23" w.c.	.4" w.c.	.5" w.c.	1" w.c.
Increase in outlet pressure required for no flow	0.2" wc	0.2" wc	0.4" wc	0.8" wc	1.0" wc

 Do not use this orifice size at this inlet pressure

Max. capacities on inches w.c. outlet:  
 1-1/2" outlet connection - 12,000 scfh  
 2" outlet connection - 20,000 scfh  
 3" outlet connection (2" I.P.S.) - 20,000 scfh

# B38 Commercial & Industrial Regulator - 7" (17 mbar)

## Typical Performance Curves

Type and Model.....B38 IM  
Regulator:

- Inlet Size .....2" NPT
- Outlet Size.....2" NPT
- Orifice Size .....1/4" x 3/8"
- Spring .....Green

Set Point 7" w.c. with 40 psig inlet @ 200 scfh. All test results are reported at a base of 14.7 psia and 60 F.

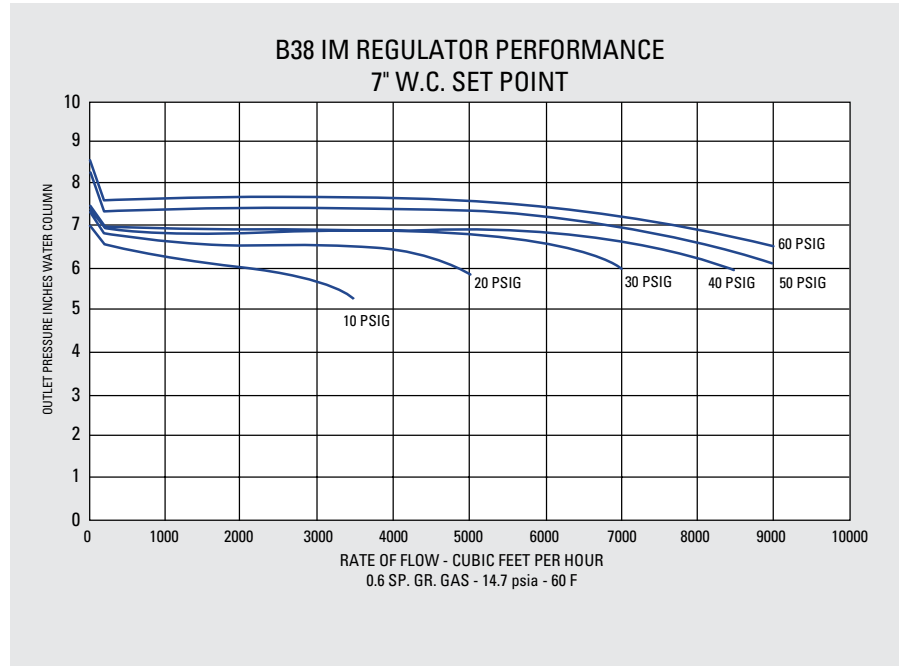

## Relief Characteristic Curves R Model Only

Type and Model.....B38 IMR  
Regulator:

- Inlet Size .....2" NPT
- Outlet Size.....2" NPT
- Vent Size .....2-1/2" NPT

Set Point 7" w.c. with 40 psig inlet @ 200 scfh. All test results are reported at a base of 14.7 psia and 60 F.

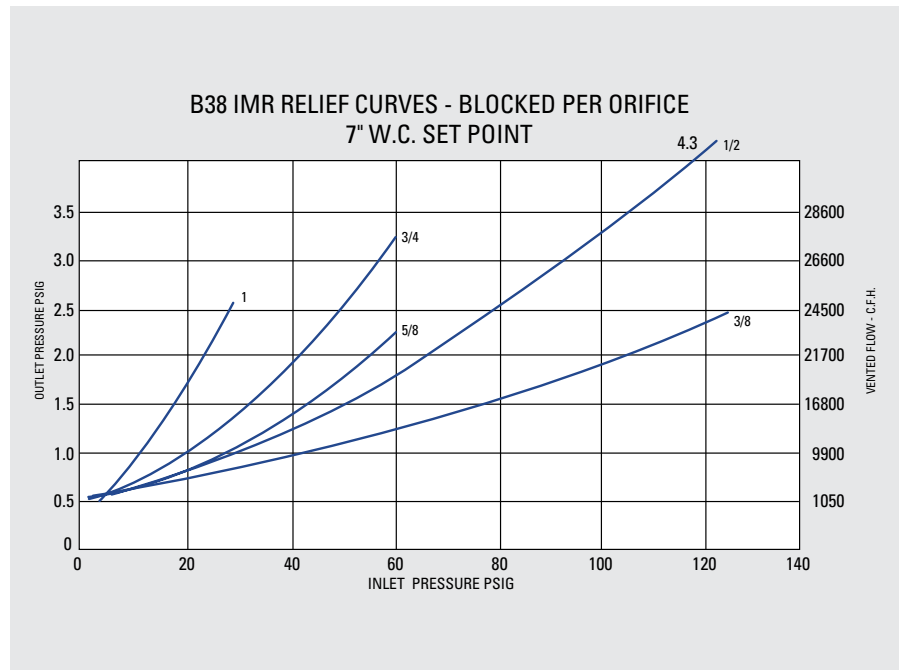

# B38 Commercial & Industrial Regulator - 1 psig (69 mbar) Capacity Table (1% absolute Droop) – Models IMN, IMR, IMRV

Set Point: 1 psig (69 mbar) @ 200 scfh (5.68 m<sup>3</sup>/h)  
2" X 2" NPT Valve Body

Loading Ring Setting: 0 degrees  
Blue/White Spring - Part No. 762358

Mounting Position 11

Inlet Pressure		Capacities in scfh (m <sup>3</sup> /hr) by Orifice Size									
		3/8" 9.52 mm		1/2" 12.7 mm		5/8" 15.9 mm		3/4" 19.1 mm		1" 25.4 mm	
Psig	Bar										
2	0.138	500	(14.00)	700	(19.60)	1600	(44.80)	1700	(47.60)	2400	(67.20)
3	0.207	750	(21.00)	1200	(33.60)	2000	(56.00)	2300	(64.40)	2900	(81.20)
5	0.345	1400	(39.20)	1900	(53.20)	3000	(84.00)	3300	(92.40)	4200	(117.60)
10	0.69	2000	(56.00)	2900	(81.20)	4800	(134.40)	600	(16.80)	7000	(196.00)
20	1.38	3500	(98.00)	5100	(142.80)	8300	(232.40)	9500	(266.00)	11300	(316.40)
30	2.07	5000	(140.00)	7000	(196.00)	11300	(316.40)	12300	(344.40)	15000	(420.00)
40	2.76	6000	(168.00)	9000	(252.00)	14000	(392.00)	15700	(439.60)		
50	3.45	8500	(238.00)	11000	(308.00)	16500	(462.00)	17200	(481.60)		
60	4.14	9600	(268.80)	12700	(355.60)	18000	(504.00)	19500	(546.00)		
70	4.83	11235	(314.58)	14980	(419.44)						
80	5.52	12995	(363.86)	16159	(452.45)						
90	6.21	13924	(389.87)	17110	(479.08)						

Change in outlet for a 10 psig (0.69 Bar) inlet change	0.01 psig	0.01 psig	0.02 psig	0.02 psig	0.04 psig
Increase in outlet pressure required for no flow	0.02 psig	0.05 psig	0.06 psig	0.09 psig	0.12 psig

Do not use this orifice size at this inlet pressure

# B38 Commercial & Industrial Regulator - 1 psig (69 mbar) Capacity Table (2% absolute Droop) – Models IMN, IMR, IMRV

Set Point: 1 psig (69 mbar) @ 200 scfh (5.68 m<sup>3</sup>/h)  
2" X 2" NPT Valve Body

Loading Ring Setting: 0 degrees  
Blue/White Spring - Part No. 762358

Mounting Position 11

Inlet Pressure		Capacities in scfh (m <sup>3</sup> /hr) by Orifice Size									
		3/8" 9.52 mm		1/2" 12.7 mm		5/8" 15.9 mm		3/4" 19.1 mm		1" 25.4 mm	
Psig	Bar										
2	0.138	750	(21.00)	1200	(33.60)	2000	(56.00)	2300	(64.40)	3300	(92.40)
3	0.207	900	(25.20)	1700	(47.60)	2600	(72.80)	3100	(86.80)	4000	(112.00)
5	0.345	1900	(53.20)	2300	(64.40)	4000	(112.00)	4400	(123.20)	5800	(162.40)
10	0.69	2700	(75.60)	3600	(100.80)	6400	(179.20)	7300	(204.40)	9000	(252.00)
20	1.38	4300	(120.40)	6300	(176.40)	10000	(280.00)	11500	(322.00)	14000	(392.00)
30	2.07	6100	(170.80)	8500	(238.00)	13500	(378.00)	15000	(420.00)	18200	(509.60)
40	2.76	7500	(210.00)	10500	(294.00)	16500	(462.00)	18000	(504.00)		
50	3.45	9000	(252.00)	12500	(350.00)	18500	(518.00)	21800	(610.40)		
60	4.14	10300	(288.40)	14300	(400.40)	21000	(588.00)	24000	(672.00)		
70	4.83	11663	(326.56)	16050	(449.40)						
80	5.52	13221	(370.19)	17515	(490.42)						
90	6.21	14160	(396.48)	19470	(545.16)						
100	6.9	15700	(439.60)	21800	(610.40)						
125	8.63	19200	(537.60)	26500	(742.00)						

Change in outlet for a 10 psig (0.69 Bar) inlet change	0.01 psig	0.01 psig	0.02 psig	0.02 psig	0.04 psig
Increase in outlet pressure required for no flow	0.02 psig	0.05 psig	0.06 psig	0.09 psig	0.12 psig

Do not use this orifice size at this inlet pressure

# B38 Commercial & Industrial Regulator - 1 psig (69 mbar)

## Typical Performance Curves

Type and Model.....B38 IM  
Regulator:

Inlet Size .....2" NPT  
Outlet Size.....2" NPT  
Orifice Size .....1/4" x 3/8"  
Spring .....Blue-White

Set Point 1 psig with 40 psig inlet @ 200 scfh. All test results are reported at a base of 14.7 psia and 60 F.

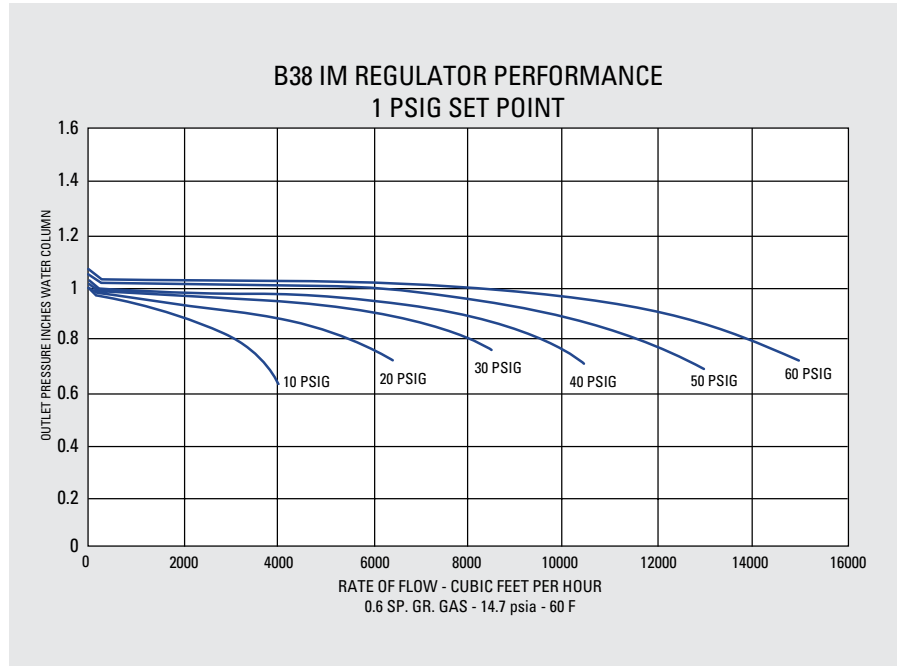

## Relief Characteristic Curves R Model Only

Type and Model.....B38 IMR  
Regulator:

Inlet Size .....2" NPT  
Outlet Size.....2" NPT  
Vent Size .....2-1/2" NPT

Set Point 1 psig with 40 psig inlet @ 200 scfh. All test results are reported at a base of 14.7 psia and 60 F.

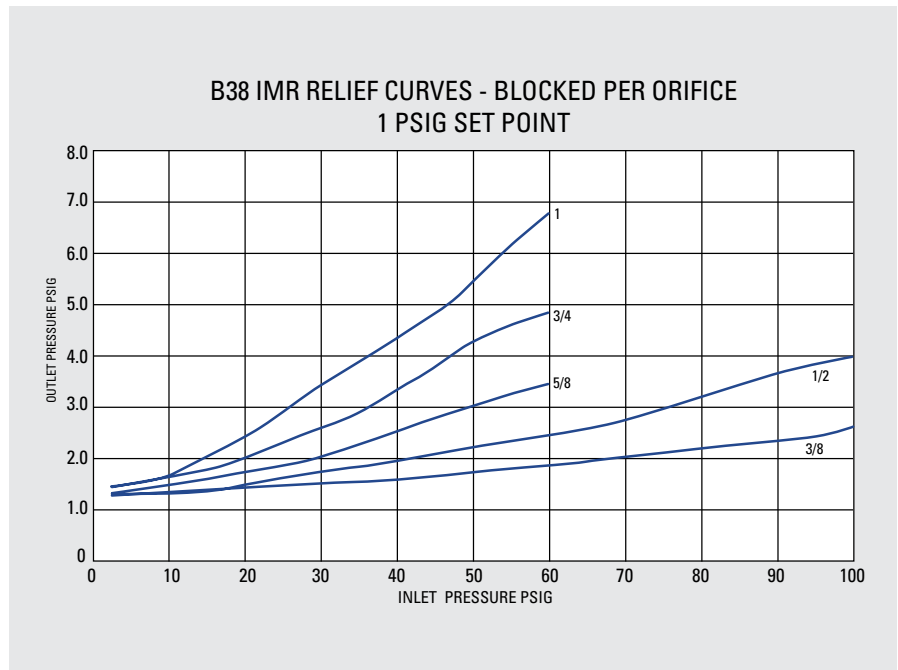

# B38 Commercial & Industrial Regulator - 2 psig (138 mbar) Capacity Table (1% absolute Droop) – Models IMN, IMR, IMRV

Set Point: 2 psig (138 mbar) @ 200 scfh (5.68 m³/h)  
2" x 2" NPT Valve Body

Loading Ring Setting: 0 degrees  
Silver-Red Spring - Part No. 762323

Mounting Position 11

Inlet Pressure		Capacities in scfh (m³/hr) by Orifice Size									
		3/8" 9.52 mm		1/2" 12.7 mm		5/8" 15.9 mm		3/4" 19.1 mm		1" 25.4 mm	
Psig	Bar										
3	0.21	400	(11.20)	750	(21.00)	800	(22.40)	1000	(28.00)	1600	(44.80)
5	0.34	900	(25.20)	1150	(32.20)	1400	(39.20)	1750	(49.00)	3000	(84.00)
10	0.69	1750	(49.00)	2300	(64.40)	2500	(70.00)	3500	(98.00)	5000	(140.00)
15	1.03	2300	(64.40)	3500	(98.00)	3300	(92.40)	5200	(145.60)	7400	(207.20)
20	1.38	2500	(70.00)	3600	(100.80)	6000	(168.00)	7500	(210.00)	8500	(238.00)
25	1.72	3600	(100.80)	5400	(151.20)	6000	(168.00)	9500	(266.00)	13300	(372.40)
30	2.07	3600	(100.80)	5700	(159.60)	8300	(232.40)	10000	(280.00)	16400	(459.20)
40	2.76	5000	(140.00)	7000	(196.00)	11500	(322.00)	14000	(392.00)		
50	3.45	6300	(176.40)	8500	(238.00)	13000	(364.00)	16500	(462.00)		
60	4.14	7400	(207.20)	14000	(392.00)	16300	(456.40)	20000	(560.00)		
70	4.83	8560	(239.68)	11984	(335.55)						
75	5.17	10600	(296.80)	15000	(420.00)						
80	5.52	10170	(284.76)	14125	(395.50)						
90	6.21	11210	(313.88)	17110	(479.08)						
95	6.55	13500	(378.00)	16500	(462.00)						
100	6.90	14100	(394.80)	17100	(478.80)						
125	8.62	17000	(476.00)	20000	(560.00)						

# B38 Commercial & Industrial Regulator - 2 psig (138 mbar) Capacity Table (2% absolute Droop) – Models IMN, IMR, IMRV

Set Point: 2 psig (138 mbar) @ 200 scfh (5.68 m³/h)  
2" X 2" NPT Valve Body

Loading Ring Setting: 0 degrees  
Silver/Red Spring - Part No. 762323

Mounting Position 11

Inlet Pressure		Capacities in scfh (m³/hr) by Orifice Size									
		3/8" 9.52 mm		1/2" 12.7 mm		5/8" 15.9 mm		3/4" 19.1 mm		1" 25.4 mm	
Psig	Bar										
3	0.21	700	(19.60)	1150	(32.20)	1500	(42.00)	1900	(53.20)	2700	(75.60)
5	0.34	1300	(36.40)	2000	(56.00)	2500	(70.00)	3300	(92.40)	4500	(126.00)
10	0.69	2500	(70.00)	3600	(100.80)	4500	(126.00)	6000	(168.00)	7300	(204.40)
15	1.03	3300	(92.40)	5000	(140.00)	6400	(179.20)	8000	(224.00)	10500	(294.00)
20	1.38	3800	(106.40)	5300	(148.40)	8500	(238.00)	10000	(280.00)	12000	(336.00)
25	1.72	5000	(140.00)	7000	(196.00)	9500	(266.00)	12500	(350.00)	16000	(448.00)
30	2.07	5300	(148.40)	7500	(210.00)	11500	(322.00)	13200	(369.60)	19300	(540.40)
40	2.76	7000	(196.00)	9200	(257.60)	14500	(406.00)	16000	(448.00)		
50	3.45	8300	(232.40)	11200	(313.60)	17000	(476.00)	20000	(560.00)		
60	4.14	9400	(263.20)	15000	(420.00)	20000	(560.00)	20000	(560.00)		
70	4.83	11235	(314.58)	15408	(431.42)						
75	5.17	11200	(313.60)	16000	(448.00)						
80	5.52	12430	(348.04)	16950	(474.60)						
90	6.21	14160	(396.48)	20060	(561.68)						
95	6.55	14000	(392.00)	19500	(546.00)						
100	6.90	14500	(406.00)	19700	(551.60)						
125	8.62	17000	(476.00)	20000	(560.00)						

Change in outlet for a 10 psig (0.69 Bar) inlet change	0.01 psig	0.01 psig	0.02 psig	0.02 psig	0.05 psig
Increase in outlet pressure required for no flow	0.03 psig	0.05 psig	0.07 psig	0.10 psig	0.14 psig

Do not use this orifice size at this inlet pressure

# B38 Commercial & Industrial Regulator - 2 psig (138 mbar)

## Typical Performance Curves

Type and Model.....B38 IM  
Regulator:

Inlet Size .....2" NPT  
Outlet Size.....2" NPT  
Orifice Size .....1/4" x 3/8"  
Spring .....Silver-Red

Set Point 2 psig with 40 psig inlet @ 200 scfh. All test results are reported at a base of 14.7 psia and 60 F.

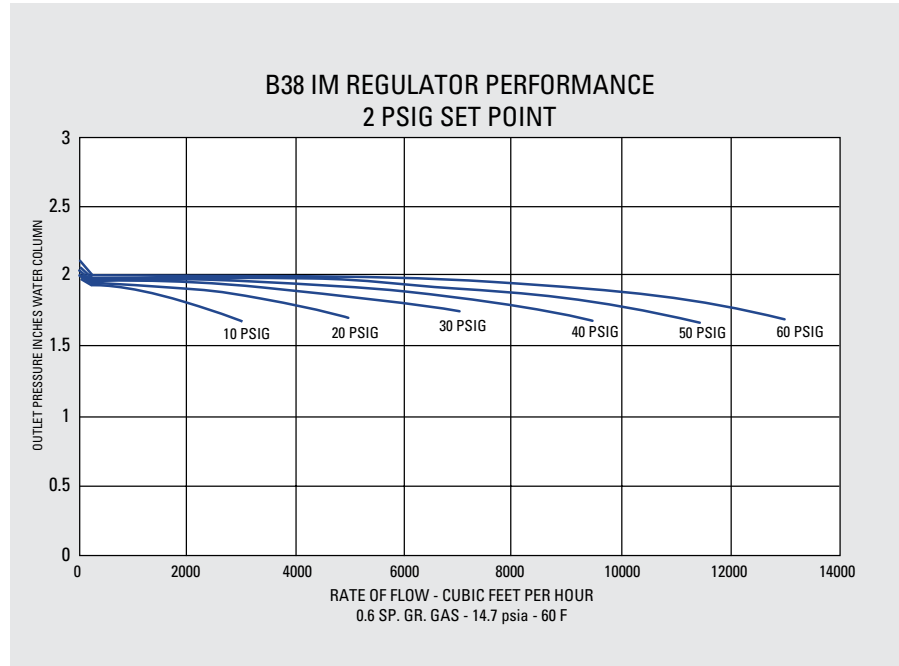

## Relief Characteristic Curves R Model Only

Type and Model.....B38 IMR  
Regulator:

Inlet Size .....2" NPT  
Outlet Size.....2" NPT  
Vent Size .....2-1/2" NPT

Set Point 2 psig with 40 psig inlet @ 200 scfh. All test results are reported at a base of 14.7 psia and 60 F.

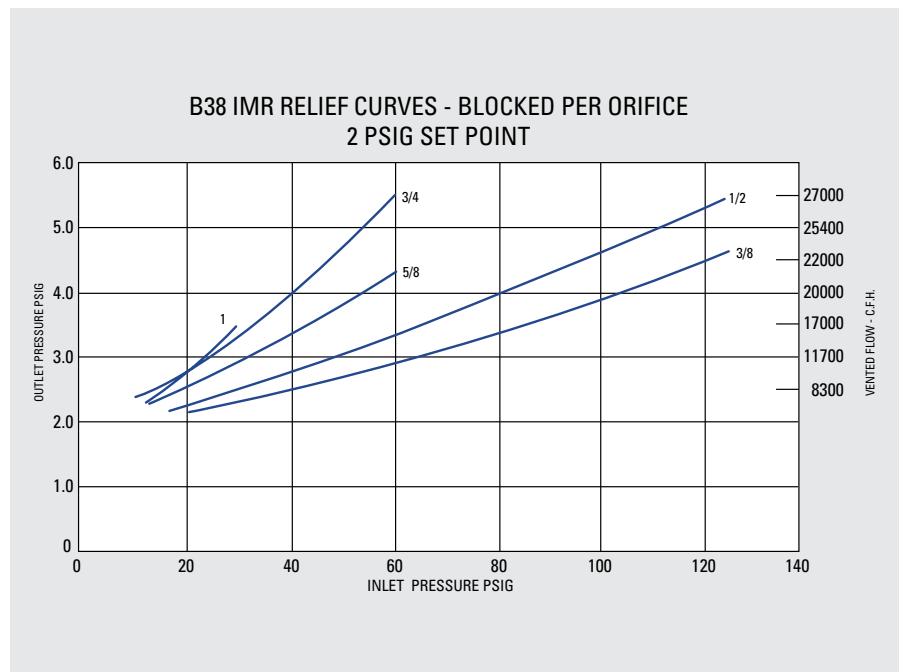

# B38 Commercial & Industrial Regulator - 5 psig (345 mbar) Capacity Table (1% absolute Droop) – Models IMN, IMR, IMRV

Set Point: 5 psig (345 mbar) @ 200 scfh (5.68 m<sup>3</sup>/h)  
2" x 2" NPT Valve Body

Loading Ring Setting: 0 degrees  
Red Nested Spring - Part No. 762671

Mounting Position 11

Inlet Pressure		Capacities in scfh (m <sup>3</sup> /hr) by Orifice Size									
		3/8" 9.52 mm		1/2" 12.7 mm		5/8" 15.9 mm		3/4" 19.1 mm		1" 25.4 mm	
Psig	Bar										
10	0.69	750	(21.00)	1000	(28.00)	1000	(28.00)	1000	(28.00)	1600	(44.80)
15	1.03	1000	(28.00)	1150	(32.20)	1700	(47.60)	1800	(50.40)	2000	(56.00)
20	1.38	700	(19.60)	1300	(36.40)	2000	(56.00)	2300	(64.40)	2500	(70.00)
25	1.72	1200	(33.60)	1700	(47.60)	2350	(65.80)	2500	(70.00)	2850	(79.80)
30	2.07	1500	(42.00)	1900	(53.20)	2500	(70.00)	3000	(84.00)	3750	(105.00)
40	2.76	1700	(47.60)	2300	(64.40)	3200	(89.60)	4000	(112.00)		
50	3.45	2000	(56.00)	2800	(78.40)	6000	(168.00)	6500	(182.00)		
60	4.14	3000	(84.00)	3050	(85.40)	7000	(196.00)	8000	(224.00)		
70	4.83	3103	(86.88)	4066	(113.85)						
75	5.17	3000	(84.00)	4200	(117.60)						
80	5.52	3616	(101.25)	5650	(158.20)						
90	6.21	4484	(125.55)	7552	(211.46)						
95	6.55	4100	(114.80)	6750	(189.00)						
100	6.90	4700	(131.60)	7500	(210.00)						
125	8.62	7500	(210.00)	11300	(316.40)						

# B38 Commercial & Industrial Regulator - 5 psig (345 mbar) Capacity Table (2% absolute Droop) – Models IMN, IMR, IMRV

Set Point: 5 psig (345 mbar) @ 200 scfh (5.68 m<sup>3</sup>/h)  
2" x 2" NPT Valve Body

Loading Ring Setting: 0 degrees  
Red Nested Spring - Part No. 762671

Mounting Position 11

Inlet Pressure		Capacities in scfh (m <sup>3</sup> /hr) by Orifice Size									
		3/8" 9.52 mm		1/2" 12.7 mm		5/8" 15.9 mm		3/4" 19.1 mm		1" 25.4 mm	
Psig	Bar										
10	0.69	1100	(30.80)	1200	(33.60)	1800	(50.40)	1800	(50.40)	2650	(74.20)
15	1.03	1600	(44.80)	1850	(51.80)	2700	(75.60)	2850	(79.80)	3500	(98.00)
20	1.38	1600	(44.80)	2100	(58.80)	3400	(95.20)	3500	(98.00)	4000	(112.00)
25	1.72	2100	(58.80)	2550	(71.40)	4000	(112.00)	4250	(119.00)	2750	(77.00)
30	2.07	2300	(64.40)	2600	(72.80)	4300	(120.40)	4500	(126.00)	7000	(196.00)
40	2.76	2700	(75.60)	3000	(84.00)	4500	(126.00)	5200	(145.60)		
50	3.45	3850	(107.80)	5800	(162.40)	8000	(224.00)	9000	(252.00)		
60	4.14	4100	(114.80)	6250	(175.00)	10500	(294.00)	11000	(308.00)		
70	4.83	5000	(140.00)	7800	(218.40)						
75	5.17	5500	(154.00)	8400	(235.20)						
80	5.52	6000	(168.00)	8800	(246.40)						
90	6.21	7500	(210.00)	10000	(280.00)						
95	6.55	7900	(221.20)	11600	(324.80)						
100	6.90	8300	(232.40)	12200	(341.60)						
125	8.62	10500	(294.00)	15000	(420.00)						

Change in outlet for a 10 psig (0.69 Bar) inlet change	0.01 psig	0.01 psig	0.02 psig	0.03 psig	0.07 psig
Increase in outlet pressure required for no flow	0.08 psig	0.11 psig	0.11 psig	0.11 psig	0.18 psig

Do not use this orifice size at this inlet pressure

# B38 Commercial & Industrial Regulator - 5 psig (345 mbar)

## Typical Performance Curves

Type and Model.....B38 IM  
Regulator:

- Inlet Size .....2" NPT
- Outlet Size.....2" NPT
- Orifice Size .....1/4" x 3/8"
- Spring .....Blue-White

Set Point 5 psig with 40 psig inlet @ 200 scfh. All test results are reported at a base of 14.7 psia and 60 F.

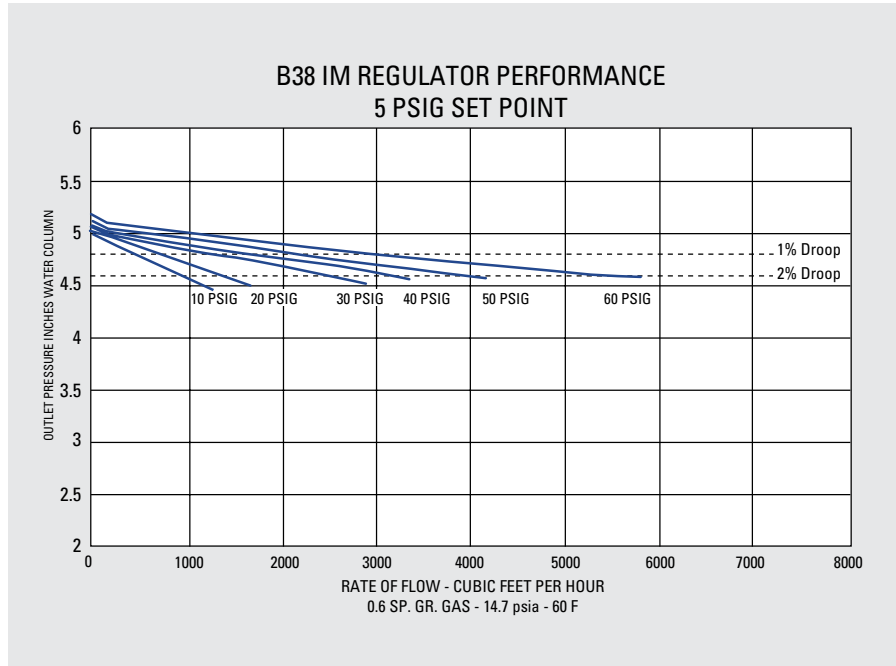

## Relief Characteristic Curves R Model Only

Type and Model.....B38 IMR  
Regulator:

- Inlet Size .....2" NPT
- Outlet Size.....2" NPT
- Vent Size .....2-1/2" NPT

Set Point 5 psig with 40 psig inlet @ 200 scfh. All test results are reported at a base of 14.7 psia and 60 F.

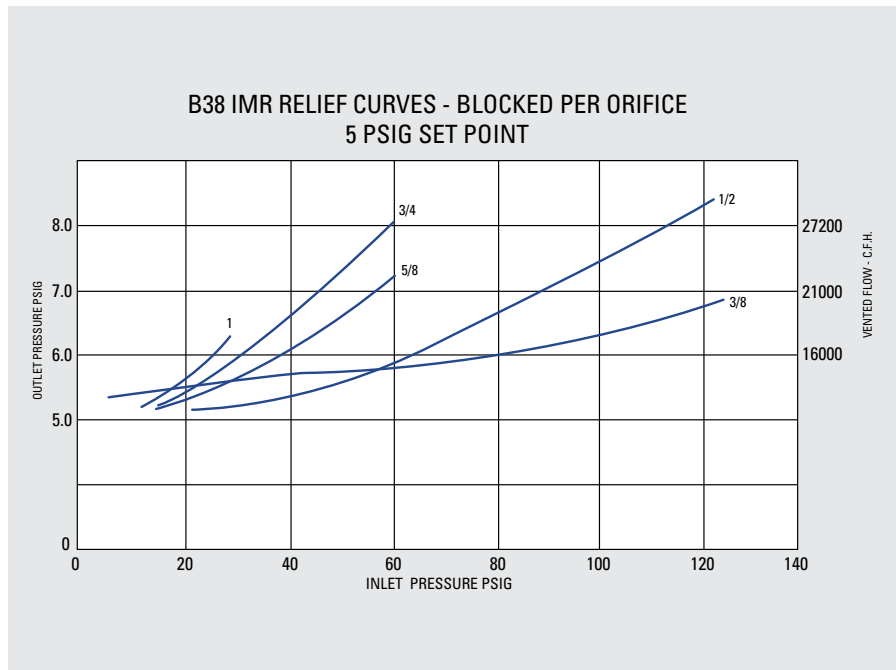

# Installation

- A. Make certain all shipping plugs are removed from the inlet, outlet and vent of any regulator before installation.
- B. When installing the regulator, the inside of the piping and the regulator inlet and outlet are to be clean, free of dirt, pipe dope and other debris to prevent entry into the regulator which could cause loss of pressure control.
- C. The pipe joint sealant should be applied on the male threads of the pipe. Do not use any pipe joint material on the female threads of the regulator or it could become lodged in the regulator causing possible loss of pressure control.
- D. Gas must flow through the valve body of the regulator in the same direction as the arrow cast on the body, or the outlet side of the regulator may be overpressured and damaged.
- E. The diaphragm casing may be mounted in any position relative to the body through a full 360° angle.
- F. When the regulator is installed OUTDOORS, the vent must always be positioned so that rain, snow, moisture or foreign particles cannot enter the vent opening. It is recommended that the vent be positioned to face downward so as to avoid entry of water or other matter which could interfere with the proper operation of the regulator. The vent should be located away from building eaves, window openings, building air intakes and above the expected snow level at the site. The vent opening should be inspected periodically to insure it does not become blocked by foreign material.
- G. When the regulator is installed INDOORS, the vent must be piped to the outside atmosphere while using the shortest length of pipe, the least number of elbows, and having as large a pipe diameter as the vent size or larger. USING VENT PIPE ANY SIZE SMALLER THAN THE VENT CONNECTION WILL LIMIT THE REGULATOR'S INTERNAL RELIEF VALVE CAPACITY. The outlet end of the pipe must be protected from moisture and the entrance of foreign particles. The regulator should be specified by the user with the size vent and pipe threads desired to make the vent pipe connection.

## START-UP PROCEDURE

- A. A pressure gauge should be mounted downstream of the regulator to monitor the downstream pressure.
- B. With the downstream valve closed, slowly open the inlet valve. The outlet pressure should rise to slightly greater than the set-point.
- C. Be sure there are no leaks and all connections are tight.
- D. The regulator has been preset at the factory to match specifications given when it was ordered. The outlet pressure may be adjusted by removing the seal cap on top of the spring housing and adjusting the ferrule or screw inside the spring housing using a ratchet with a socket and an extension. With a small amount of gas flowing through the regulator, rotate the ferrule clock-wise to raise the outlet pressure and counter-clockwise to lower the outlet pressure.
- E. After the desired outlet pressure is achieved, replace the seal cap, recheck for leaks. The regulator is ready for operation.

## SAFETY NOTES:

- A. The maximum inlet pressure for this regulator is dependent upon the size of the orifice and model designation. The non-relief models are limited to 60 psig maximum inlet pressure unless addition safety devices are used as outlined in DOT code, OPS, Part 192, section 192.197.
- B. When these models are used on liquid petroleum gases, they should be restricted to second-stage pressure reduction in the gaseous phase.

## SAFETY WARNING:

This product, as of the date of manufacture, is designed and tested to conform to all governmental or industry safety standards then existing as may apply to the manufacturer.

The purchaser and user of this product are warned that compliance with the manufacturer's instructions and procedures is required in order to avoid the hazards of leaking gas resulting from improper installation, start-up or use of this product, and further, that all area fire control, building codes or other safety regulations established under public laws which regulate or concern the application, installation, operation or general use of this product should be complied with.

In order to insure the safe and proper operation of this product, the manufacturer recommends that this product be installed by a qualified installer.

# Loading Ring Adjustment Instructions

## Function

The purpose of the loading ring (Figure 1) and deflector ring is to draw gas from the underside of the diaphragm. The objective is to lower pressure under the diaphragm as the spring loses compression. The loss in spring compression occurs as the diaphragm drops to open the valve. Lowering of the pressure under the diaphragm relative to the downstream pressure strokes the valve open, thus delivering more gas to the downstream and effectively raising (or boosting) the pressure.

## Adjustment

The B38 is equipped with a ported metal loading ring (Figure 1). It is a heat-treated spring steel stamping with two beads (Figure 2) which fit into a groove on the orifice. The orifice also has a radial notched shoulder into which a tip (Figure 2) on the ring rests. This locks the ring from turning after it has been positioned.

After removing the diaphragm case from the valve body, remove the loading ring from the orifice by spreading the loading ring slightly with both thumbs (Figure 3). Insert the loading ring on the orifice with the center of the loading ring opening (Figure 1) aligned with the casting seam (Figure 4) on the downstream side. The loading ring is now in the 0° position. The angle between each notch on the



Figure 1

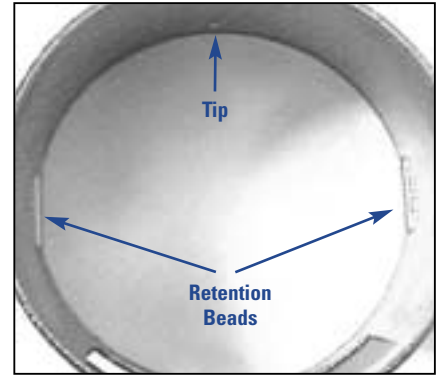

Figure 2



Figure 3

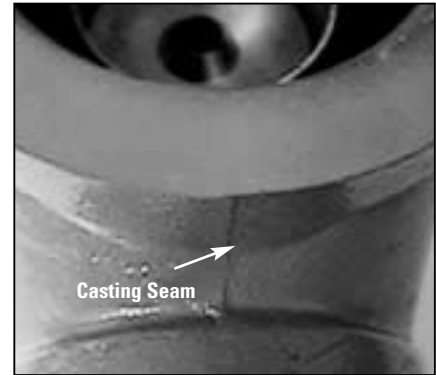

Figure 4

B38 orifice is 1.9°. Divide the desired angle (see capacity tables for recommended loading ring position) by 1.9 and round this number up to the nearest whole number (Example:  $10.4 = 11$  notches). This is the required number of notches the loading ring must be turned. The loading ring may be adjusted either clock-wise or counter-clock-wise. Using two thumbs as shown in Figure 3, rotate the loading ring the required number of notches. Replace the diaphragm case, slowly open the upstream valve and check for any leaks. The regulator is now ready for operation.

## Ordering Information

Specify:

1. Inlet and Outlet Connection Size and Type
2. Model Number
3. Outlet pressure desired
4. Inlet pressure range
5. Type of gas and maximum capacity required
6. Assembly position number (see chart at right)
7. Vent size
8. Special requirements such as tagging, 1/8" pipe plug tap, seal wire, etc.

## Assembly Positions

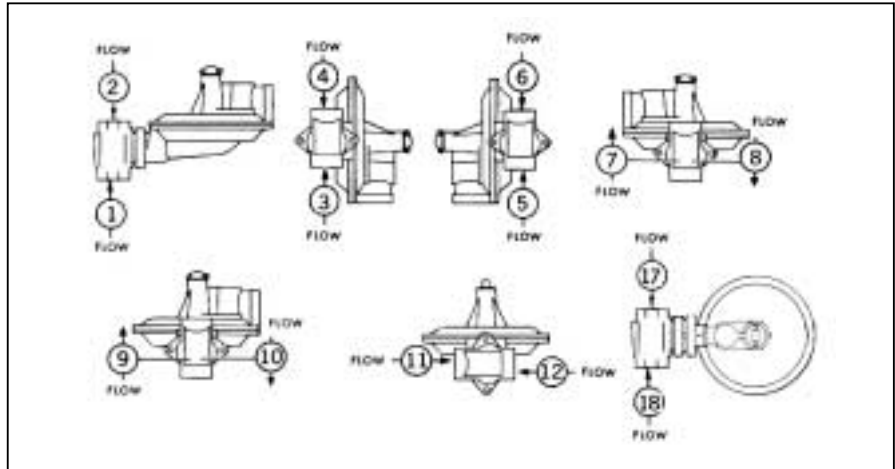

## Warranty

Actaris Metering Systems, 970 Highway 127 North, Owenton, Kentucky 40359-9802, warrants this gas product against defects in materials and workmanship for the earlier of one (1) year from the date the product is shipped by Actaris or a period of one year from the date the product is installed by Actaris at the original purchaser's site. During such one-year period, provided that the original purchaser continues to own the product, Actaris will, at its sole option, repair any defects, replace the product or repay the purchase price.

This warranty will be void if the purchaser fails to observe the procedures for installation, operation or service of the product as set forth in the Operating Manual and Specifications for the product or if the defect is caused by tampering, physical abuse or misuse of the product.

Actaris specifically disclaims all

implied warranties including those of merchantability or of fitness for a particular purpose. Under no circumstances will Actaris be liable for incidental or consequential damages of any kind whatsoever.

Actaris' liability for any claim of any kind, including negligence and breach of warranty for the sale and use of any product covered by or furnished, shall in no case exceed the price allocable to the product or part thereof which gives rise to the claim.

In the event of a malfunction of the product, consult your Actaris Service Representative or Actaris Metering Systems, 970 Highway 127 North, Owenton, Kentucky 40359-9802.

### Actaris Metering Systems

970 Highway 127 North  
Owenton, Kentucky 40359-9302, USA  
Tel.: +1 800 490 0657  
+1 502 484 5747  
Fax: +1 502 484 6223

[www.ActarisUSgas.com](http://www.ActarisUSgas.com)

K20H - 6/02  
© Copyright 2002, Actaris U.S. Gas, Inc.

